

AREA “H”

SIMILKAMEEN
VALLEY



Zoning Bylaw No. 3065, 2024 - Regional District of Okanagan-Similkameen

ZONING BYLAW



Regional District of Okanagan-Similkameen Electoral Area “H” Zoning Bylaw No. 3065, 2024

TABLE OF CONTENTS

	Page
1.0 TITLE AND APPLICATION.....	2
2.0 TRANSITION	3
3.0 ADMINISTRATION	5
4.0 DEFINITIONS	7
5.0 CREATION OF ZONES	25
6.0 GENERAL REGULATIONS	27
6.1 Cannabis Production	27
6.2 Fence Heights.....	27
6.3 Height Exemptions.....	28
6.4 Keeping of Livestock and Honeybees	28
6.5 Metal Storage Containers	29
6.6 Mobile Vendor	29
6.7 Occupancy of an Existing Dwelling During Construction of a New Dwelling	29
6.8 Prohibited Uses of Land, Buildings and Structures.....	29
6.9 Recreational Vehicles.....	30
6.10 Residential Density Calculation.....	30
6.11 Retaining Walls	31
6.12 Setback Exemptions	32
6.13 Uses Permitted in Every Zone.....	33
6.14 Visibility at Intersections.....	33
7.0 SPECIFIC USE REGULATIONS	35
7.1 Accessory Buildings and Structures	35
7.2 Accessory Dwellings.....	35
7.3 Agri-Tourism Accommodation	36
7.4 Bed and Breakfast Operations.....	36

7.5	Home Industry	37
7.6	Home Occupation	38
7.7	Kennel Facilities	39
7.8	Retail Sales of Farm Products	39
7.9	Secondary Suites	39
8.0	SUBDIVISION REGULATIONS	40
9.0	SIGNAGE REGULATIONS	42
10.0	FLOODPLAIN REGULATIONS.....	44
11.0	VEHICLE PARKING & LOADING REGULATIONS	47
12.0	RESOURCE AREA ZONES	51
12.1	RESOURCE AREA (RA) ZONE.....	51
12.2	WATERSHED RESOURCE AREA (WRA) ZONE.....	58
13.0	AGRICULTURE ZONES	62
13.1	AGRICULTURE THREE (AG3) ZONE.....	62
14.0	LARGE HOLDINGS ZONES	66
14.1	LARGE HOLDINGS ONE (LH1) ZONE	66
14.2	LARGE HOLDINGS TWO (LH2) ZONE	69
15.0	SMALL HOLDINGS ZONES.....	74
15.1	SMALL HOLDINGS ONE (SH1) ZONE.....	74
15.2	SMALL HOLDINGS TWO (SH2) ZONE.....	76
15.3	SMALL HOLDINGS THREE (SH3) ZONE	78
15.4	SMALL HOLDINGS FOUR (SH4) ZONE.....	80
16.0	LOW DENSITY RESIDENTIAL ZONES	83
16.1	LOW DENSITY RESIDENTIAL ONE (RS1) ZONE.....	83
16.2	LOW DENSITY RESIDENTIAL MANUFACTURED HOME PARK (RSM1) ZONE	85
17.0	COMMERCIAL ZONES	88
17.1	GENERAL COMMERCIAL (C1) ZONE	88
17.2	SERVICE COMMERCIAL (CS1) ZONE	90
18.0	TOURIST COMMERCIAL ZONES	92
18.1	TOURIST COMMERCIAL (CT1) ZONE	92
18.2	CAMPGROUND COMMERCIAL (CT2) ZONE.....	96

18.3	GOLF COURSE COMMERCIAL (CT3) ZONE	98
19.0	INDUSTRIAL ZONES	99
19.1	GENERAL INDUSTRIAL (I1) ZONE.....	99
19.2	HEAVY INDUSTRIAL (I2) ZONE.....	101
20.0	ADMINISTRATIVE & INSTITUTIONAL ZONES	103
20.1	ADMINISTRATIVE AND INSTITUTIONAL (AI) ZONE	103
21.0	PARKS & NATURAL ENVIRONMENT ZONES	105
21.1	PARKS AND RECREATION (PR) ZONE	105
21.2	CONSERVATION AREA (CA) ZONE	107
22.0	COMPREHENSIVE DEVELOPMENT	109
22.1	ELKHART LODGE COMPREHENSIVE DEVELOPMENT (CD3) ZONE.....	109
22.2	KENNEDY LAKE COMPREHENSIVE DEVELOPMENT ZONE (CD6).....	111

LIST OF SCHEDULES

Schedule '1' – Electoral Area “H” Zoning Text

Schedule '2' – Electoral Area “H” Zoning Maps

Schedule '3' – Provincial Floodplain Maps

Schedule '4' – Kennedy Lake Recreation Use Areas

Regional District of Okanagan-Similkameen Electoral Area “H” Zoning Bylaw No. 3065, 2024

A Bylaw to divide part of the Regional District within
Electoral Area “H” into zones and regulate within the zones:

1. the use of land, *buildings* and *structures*,
2. the density of the use of land, *buildings* and *structures*,
3. the siting, size and dimensions of:
 - a) *buildings* and *structures*, and
 - b) uses that are permitted on the land,
4. the shape, dimensions and area, including the establishment of maximum and minimum sizes of all *parcels* of land that may be created by subdivision,
5. the provision of off-street parking and loading spaces,
6. the provision of *screening* or landscaping,
7. floodplain regulations, and
8. other matters under provincial empowering enactments.

The Regional Board of the Regional District of Okanagan-Similkameen ENACTS as follows:

1.0 TITLE AND APPLICATION

1.1 Title

This Bylaw may be cited for all purposes as the “Regional District of Okanagan-Similkameen Electoral Area “H” Zoning Bylaw No. 3065, 2024”.

1.2 Application

This Bylaw applies to all lands, including the surface of water and all uses, *buildings* and *structures* located within that portion of Electoral Area “H” of the Regional District of Okanagan-Similkameen as shown by map reference on Schedule ‘2’, which is attached to and forms part of this Bylaw. This Bylaw includes:

Schedule ‘1’ – Zoning Text

Schedule ‘2’ – Zoning Maps

Schedule ‘3’ – Provincial Floodplain Maps

Schedule ‘4’ – Kennedy Lake Recreation Use Areas

2.0 TRANSITION

The Electoral Area “H” Zoning Bylaw No. 2498, 2012, as amended, is repealed.

READ A FIRST AND SECOND TIME on the 13th day of June, 2024.

PUBLIC HEARING held on the 4th day of July, 2024.

READ A THIRD TIME on the 4th day of July, 2024.

Approved by the Minister of Transportation and Infrastructure, on the 9th day of July, 2024.

ADOPTED on the 25th day of July, 2024.

Chair

Corporate Officer

SCHEDULE '1'

Regional District of Okanagan-Similkameen

Electoral Area "H" Zoning Bylaw No. 3065, 2024

3.0 ADMINISTRATION

3.1 Applicability

- .1 Land or the surface of water must not be used, land shall not be subdivided and *buildings* or *structures* must not be constructed, altered, located or used except as specifically permitted in this Bylaw.
- .2 All uses permitted by this Bylaw include, except as otherwise specifically stated, all uses reasonably accessory and exclusively devoted to the *principal uses*.
- .3 *Parcels* shall be consolidated prior to issuance of building permit where the proposed *building* would otherwise straddle the *parcel* line.

3.2 Enforcement

- .1 The Chief Administrative Officer, or their delegate, is authorized at all reasonable times to enter on any property that is subject to regulation under this Bylaw, to ascertain whether the regulations, prohibitions or requirements under this Bylaw are being observed.

3.3 Prohibitions and Penalties

- .1 A person shall not prevent or obstruct, or attempt to prevent or obstruct, a person, an officer or an employee authorised under section 3.2 from entering property to ascertain whether regulations, prohibitions or requirements of this Bylaw are being met or observed.
- .2 Any person who violates a provision of this Bylaw commits an offence and is liable on summary conviction to a fine not exceeding \$10,000.00 and the costs of prosecution.
- .3 Each day's continuance of an offence under this Bylaw constitutes a new and distinct offence.

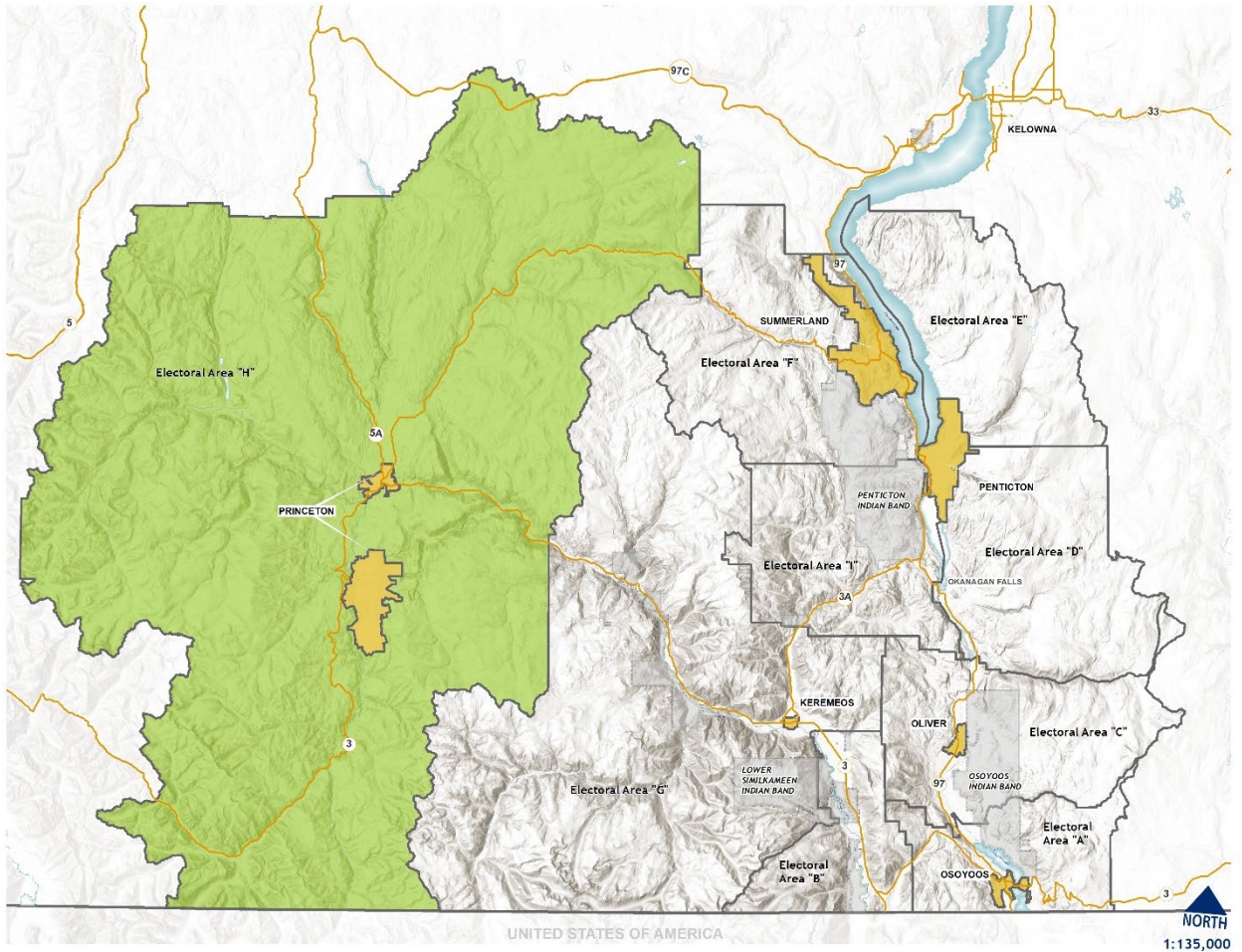

Map 1 — Context Map

4.0 DEFINITIONS

In this Bylaw:

A

“accessory building or structure” means a detached *building* or *structure* located on the same *parcel* as the *principal building*, the use of which is subordinate, customarily incidental, and exclusively devoted to that of the *principal building*;

“accessory dwelling” means a *dwelling unit* which is permitted as an *accessory use* in conjunction with a *principal use* and is not located entirely within a *single detached dwelling*;

“accessory use” means a use which is subordinate, customarily incidental, and exclusively devoted to a *principal use* in existence on the same *parcel*;

“affordable housing” means any housing where the annual cost of owning including taxes, condominium fees and mortgage, principal, and interest payments as amortized over 25 years with a 10% down payment, or gross rent, does not exceed 30% of the average annual individual income within the relevant Okanagan-Similkameen ‘Subdivision’ as defined by Census Canada;

“agriculture” means the use of land, *buildings* or *structures* for growing, harvesting, packing, storing and wholesaling of agricultural crops for the purposes of providing food, horticultural, medicinal or *farm products*, but excludes processing and *retail sales of farm products* and *cannabis production, indoor*. Agriculture includes *cannabis production, outdoor*, producing and rearing animals and *range grazing* of horses, cattle, sheep, and other *livestock, composting operation* and includes *apiculture* and *aquaculture*;

“agriculture, indoor” means the use of a *building* or *structure* for the growing, harvesting, cultivating, propagating, packing, storing and wholesaling of horticultural products, including but not limited to, vegetables, fruits, nuts and flowers, and *cannabis production, indoor*;

“agri-tourism” means a tourist activity, service or facility carried out as an *accessory use* on land that is classified as a farm under the *Assessment Act*;

“agri-tourism accommodation” means accommodation for rental to the traveling public on an operating farm or ranch, which is carried out as an accessory to the principal *farm use* of the *parcel*;

“airstrip” means an unpaved runway for the landing and takeoff of aircraft, but excludes facilities associated with an airport such as aircraft maintenance and repair, fuel sales, and storage hangers;

“alcohol production facility” means a brewery, cidery, distillery, meadery or *winery* that is licenced under the *Liquor Control and Licensing Act* to produce beer, cider, spirits, mead or wine;

“amenity and open space area” means a useable outdoor area or common indoor recreation area, not including the front and side *setback* areas and parking areas, which is for the recreational use of the residents of a *dwelling unit* or *building*, and may include balconies, patios, decks, gardens, amenity rooms and lounges and landscaped recreation areas;

“animated sign” means a *sign* which includes action, motion, rotation, or flashing of all or any part of the *sign*;

“apartment building” means a *building* other than a *townhouse* containing three (3) or more *dwelling units*, each of which has its principal access from an entrance common to the dwellings;

“apiculture” means the keeping and raising in apiaries of honey bees for honey production, crop pollination, and bee stock production;

“aquaculture” means the growing and cultivation of aquatic plants, or fish, for commercial purposes, in any water environment or in human made containers of water, and includes the growing and cultivation of shellfish on, in or under the foreshore or in the water;

“art gallery” means a *building* or part of a *building* where works of art, such as paintings, sculpture, pottery, glass or weaving are displayed for public viewing, sale or both;

“asphalt plant” means the processing and *manufacturing* of road paving materials from raw material and petroleum products;

“assembly” means a *building* or land used for the gathering of persons for charitable, civic, cultural, educational, entertainment, philanthropic, political, recreational or religious purposes, and includes a *church* and community hall

“attic” means the space between the underside of the roof sheathing and the top of the ceiling joists or floor joists of the storey immediately below where the vertical clear *height* does not exceed 1.5 metres;

“awning sign” means a *sign* painted on, attached to, or constructed in or on the surface of an awning supported entirely from the exterior wall of a *building* and composed of non-rigid materials except for the supporting framework;

B

“bed and breakfast operation” means an occupation conducted within a *principal dwelling unit*, by the residents of the *dwelling unit*, which provides sleeping accommodations to the traveling public and may include the provision of meals for those persons using the sleeping accommodations;

“boat lift” means a *structure* supported from the bottom of a lake, which facilitates the removal of a boat from the water, and may allow for a boat to be stored above the water;

“boat launch” means a ramp into a lake that is intended to be used for the purpose of placing or removing a boat in the water;

“building” means any *structure* consisting of a roof supported by walls or columns used or intended to be used for sheltering, accommodating or enclosing people, animals, goods, chattels or equipment;

C

“campground” means a *parcel* of land occupied and maintained for temporary accommodation (maximum 30 days) of the traveling public in tents, *tourist cabins* or recreation vehicles which are licensed for the current year and have been brought to the site by the traveler. May include an *office* as part of the permitted use but excludes *hotels, manufactured homes, manufactured home parks, motels* or park model trailers;

“cannabis” means any plant of the genus *cannabis*; including:

- a) any part of a *cannabis* plant, including the phytocannabinoids produced by, or found in, such a plant, regardless of whether that part has been processed or not;
- b) any substance or mixture of substances that contains or has on it any part of such a plant; and also includes
- c) any substance that is identical to any phytocannabinoid produced by, or found in, such a plant, regardless of how the substance was obtained.

“cannabis production, indoor” means the commercial production, cultivation, synthesis, harvesting, altering or propagating of *cannabis* inside a *structure*, as permitted by federal enactment, but excludes the growing of *cannabis* by an individual for their personal use and consumption, or *cannabis production, outdoor*;

“cannabis production, outdoor” means the commercial production, cultivation, synthesis, harvesting, altering or propagating of *cannabis* outside in a field, as permitted by federal enactment, but excludes the growing of *cannabis* by an individual for their personal use and consumption, or *cannabis production, indoor*;

“cannabis products” means plant material from *cannabis* and any products that include *cannabis* or *cannabis* derivatives, intended for human use or consumption;

“canopy sign” means a *sign* which is painted, attached or constructed on the surface of an unenclosed permanent roofed *structure*;

“carport” means a roofed *structure* to be used to shelter parked vehicles or equipment, which is not enclosed on at least two sides, one being the side fronting the driveway;

“child care centre” means a *building* or *structure* in which child care services are provided for more than eight (8) children in accordance *Child Care Licensing Regulation* under the *Community Care and Assisted Living Act*;

“church” means a *building or structure* used for religious worship or organized religious services and associated *accessory uses* which may include an auditorium, *child care centre* and one (1) *accessory dwelling*;

“civic facility” means a *building or structure* in which government services are provided to the public including but not limited to a government *office*, law court, health care centre or hospital, fire hall, library, ambulance or police station;

“commercial card-lock facility” means a premises used for the bulk storage and sale of petroleum products dispensed from pumps utilizing a card-lock or key-lock system, but excludes a *service station*;

“community care facility” means premises for the accommodation and care of persons who require continuing assistance due to age, medical infirmity or disability. A *community care facility* may or may not be licensed under the *Community Care and Assisted Living Act*;

“composting operation” means the entire area, *buildings*, and equipment used for the biological decomposition of organic materials, substances or objects under controlled circumstances in composting storage facilities and composting storage sites;

“concrete plant” means the processing, *manufacturing* and sale of concrete, and includes the accessory manufacture and sales of products made from concrete;

“conservation area” means land that is preserved and protected in a natural state, and may be owned by an individual, the Province including ecological reserves or protected areas, the Canadian Wildlife Service, The Nature Trust, The Land Conservancy, Regional District of Okanagan-Similkameen, the public or other not for profit organizations interested in conservation for the prime purpose of conserving natural habitat. Typical examples include but are not limited to land protected in a natural state for the purpose of conserving plant life and providing sanctuary, habitat and breeding grounds for wildlife or fish, but excludes *indoor recreation* and *outdoor recreation*;

“construction supply centre” means the *retail sale* or wholesale of *building material*, fixtures, or hardware, garden furniture, construction and home improvement equipment or supplies, animal feed, farm supplies, and includes a lumber yard, building supply outlet, home improvement centre, and the accessory rental of home construction, maintenance or repair equipment;

“convenience store” means a retail sales outlet for the sale of foodstuffs, periodicals, sundries, fresh fruit and vegetables, hygienic or cosmetic goods or plants to serve the residents of the surrounding community on a day to day basis, which may include a confectionery, delicatessen, meat market, bakery, automated banking machines and depots for postal services, and which has a maximum gross retail floor area including storage of 250 m²;

“cooking facility” means facilities for the storage, preparation or cooking of food, and includes any room containing counters, cabinets, sinks, stoves, dishwashers and other appliances, plumbing, or

wiring which, may be intended or used for the preparation or cooking of food, but excludes a *wet bar*;

“**crawl space**” means the space between the underside of the joists of the floor next above and the ground floor slab or ground surface where no slab exists, having a vertical clear *height* less than 1.5 metres;

“**cultural facility**” means a *building* or *structure* used for artistic performances and the display of art and cultural artefacts, including but not limited to *art gallery*, community theatre and museum;

D

“**derelict vehicle**” includes a vehicle, except a farm vehicle, that is not displaying a current licence, pursuant to Provincial regulations, and which is not enclosed within a garage or *carport*;

“**designated flood**” means a flood, which may occur in any given year, of such magnitude as to equal a flood having a 200-year recurrence interval, based on a frequency analysis of unregulated historic flood records or by regional analysis where there is inadequate *watercourse* flow data available;

“**designated flood level**” means an observed or calculated water level attained by a *designated flood*, which is used in the calculation of the flood construction level;

“**development**” means any activity carried out in the process of clearing or preparing a site or constructing or erecting *structures*;

“**dock**” means an aquatic *structure* used for the purpose of mooring boats and for providing pedestrian access to and from the moored boats, but excludes the *moorage* of float planes, a *group moorage facility*, a *strata moorage facility* or a *marina*;

“**duplex dwelling**” means a *building* containing two *principal dwelling units* with each unit having an independent exterior entrance, and may contain a *secondary suite* if permitted in the applicable zone;

“**dwelling unit**” means one or more habitable rooms constituting one self-contained unit which has a separate entrance, and which contains washroom facilities, and not more than one set of *cooking facilities* (unless a *secondary suite* is permitted in the applicable zone), and which is designed to be used for living and sleeping purposes;

E

“**eating and drinking establishment**” means a *development* where prepared foods and beverages are offered for sale to the public for consumption within the premises or off the site and includes neighbourhood pubs, licensed restaurants, lounges, cafes, delicatessens, tea rooms, dining rooms, drive-in food services, refreshment stands and take-out restaurants but excludes *mobile vendor*;

“educational facility” means the use of land, *buildings* or *structures* for education, instruction and training and may include administration *offices* and dormitories to house students. Typical examples include but are not limited to elementary, middle and secondary schools, storefront schools, community colleges, universities, technical and vocational schools;

“electronic changeable copy sign” means any *sign* on which copy can be displayed utilizing electronic screens, televisions, computer video monitors, liquid crystal displays, light emitting diode displays, or any other similar electronic technology;

“equestrian centre” means the use of riding arenas, stables, training tracks and other *structures* that accommodate the activity of riding horses, and in which horses are sheltered and fed;

“exterior side parcel line” means any *parcel* line common to a *highway*, other than a *lane*, which is not a *front parcel line*;

F

“family” means one or more persons related by marriage, blood, common law, adoption or foster parenthood, and not more than five (5) unrelated persons sharing one *dwelling unit* typical of a single-family unit or other similar basic social unit;

“farm building” means a *building* or part thereof which is associated with and located on land devoted to the practice of *agriculture*, and used for the housing of equipment or *livestock*, or the production, storage, processing, marketing and selling of agricultural and horticultural produce or feeds;

“farm operation” means a farm operation as defined in the *Farm Practices Protection (Right to Farm) Act*;

“farm products” means commodities or goods that are produced from a *farm use*;

“farm use” means an occupation or use of land for agricultural purposes, including farming of land, plants and animals and any other similar activity designated as farm use by Provincial regulation, and includes a *farm operation*;

“fascia sign” means a *sign* which is painted on or attached to and supported by an exterior wall or fascia of a *building* provided the face of the *sign* is parallel to the wall and does not project more than 0.3 metres beyond the wall surface;

“fence” means an artificially constructed barrier of any material or combination of materials erected to enclose or *screen* areas of land;

“finished grade” means the average finished ground level at the perimeter of a *building* or *structure*, excluding any localized mounds or depressions such as those for vehicle or pedestrian entrances;

“fleet service” means the use of a *parcel* for a fleet of vehicles for the delivery of people, goods or services, where such vehicles are not available for sale or long term lease. Typical uses include but are not limited to taxi services, bus lines, storage of a fleet of rental vehicles, and messenger and courier services, but excludes a *freight terminal*;

“floodplain” means an area of land, whether floodproofed or not, which is susceptible to flooding by a *watercourse*, lake or other body of water;

“floodplain setback” means the required minimum distance from the *natural boundary*, or other reference line of a *watercourse*, lake, or other body of water to any landfill or structural support required to elevate a floor system or pad above the flood construction level, so as to maintain a floodway and to allow for potential land erosion;

“floor area ratio” means the figure obtained when the sum of the *gross floor areas* of all the *buildings* on a *parcel* is divided by the area of the *parcel*;

“foreshore” means land lying between the highest water mark and the lowest water mark that is alternatively covered and exposed by water with the normal rise and fall of the level of the body of water;

“forestry” means the management of forests, including harvesting, silviculture, log storage and logging camps but excludes the processing of trees and wood products;

“freeboard” means a vertical distance added to a *designated flood level* used to establish a flood construction level;

“freestanding sign” means any *sign* wholly supported from the ground by a structural member or members, independently of and visibly separated from any *building* or other *structure* and permanently fixed to the ground;

“freight terminal” means premises used as an origin or destination point from which vehicles are dispatched for the delivery or pick-up of materials, goods and equipment and which may include warehouse space for the temporary storage of such materials, goods and equipment;

“front parcel line” means any *parcel* line common to a parcel and one *highway* or strata road other than a *lane*, provided that, where a parcel is contiguous to the intersection of two or more *highways* or strata roads, the *front* parcel line is the shortest *parcel* line contiguous to one of the *highways* or strata roads. Where a parcel is bisected by a *highway*, both parcel lines abutting the *highway* are considered to be front *parcel* lines;

“funeral home” means a *building* or part of a *building* wherein a licensed undertaker prepares human remains for interment and may include a chapel for funeral services (not including cremation);

G

“**golf course**” means a tract of land for playing golf, pitch and putt courses or driving ranges, including clubhouses, restaurants, pro shops and similar accessory facilities, including banquet facilities, necessary for golf purposes and which may include *buildings* necessary for the maintenance and administration of the golf course;

“**gravel processing**” means screening, sorting, crushing and storing of any earth material, but excludes subsequent *manufacturing* operations such as concrete and *asphalt plants*;

“**greenhouse**” means a *structure* covered with translucent material, and used for the purpose of growing plants, which is of sufficient size for persons to work within the *structure*;

“**gross floor area**” means the total floor area of a *building* measured to the outer limit of the exterior walls of a *building*, but excludes:

- parking areas to a maximum floor area exclusion of 45.0 m², unless such parking is a *principal* use in which case no exclusion shall be permitted;
- a swimming pool;
- unenclosed front entry porches, balconies, decks, patios, terraces, courtyards or stairways; and
- *crawl spaces* or *attics*.

“**group moorage facility**” means one or more multi-berth *docks* providing communal *moorage* to an adjacent *apartment building* or *townhouse development* or *multi-parcel residential development*, including a *strata* or *shared interest development*;

H

“**habitable area**” means, for the purpose of the flood construction level provisions of this Bylaw, any space or room within a *building* or *structure*, including a *manufactured home* or unit, which is used or is capable of being used for human occupancy or industrial, business or commercial use, or storage of goods, including equipment (and furnaces), which is susceptible to damage by floodwater;

“**hanging sign**” means a *sign* suspended under a canopy, awning, eaves or portico;

“**height**” means, when used in reference to a *building* or *structure* other than a *retaining wall*, the vertical distance from the *finished grade* to the highest point of the roof or *structure*;

“**highway**” includes a street, road, *lane*, bridge, viaduct or any other way open to public use other than a private right-of-way on private property;

“**home industry**” means an occupation or a commercial use that is accessory to the principal *residential* use of a *parcel* and may include *manufacturing*, processing, fabricating, assembling,

distributing, testing, servicing, or repairing of goods or materials including vehicle repair, maintenance and auto body shops and other similar uses;

“home occupation” means an occupation or profession that is accessory to the principal *residential* use of a *parcel* and may include home *offices*; studios; home workshops, and other similar uses;

“hooked parcel” means a *parcel* of which one portion is physically separated from the other portion by a *highway* other than a Forest Service Road, or by another *parcel*;

“hotel” means a *building* containing commercial guest *sleeping units*, and a lobby area for guest registration and access to the *sleeping units*, which may contain *accessory uses* such as a restaurant, licensed drinking facilities, accessory *retail* sales, and meeting rooms;

I

“indoor recreation” means a facility within an enclosed *building* intended for leisure activities where patrons are predominantly participants or spectators. Typical uses include amusement arcades, bingo halls, health and fitness centres, athletic facilities and ice rinks, billiard and pool halls, swimming pools, bowling alleys, theatres and concert or music halls;

“institutional camp” means the use of land, *buildings* or *structures* to provide recreational, education, health, religious or spiritual programs, sleeping accommodation (e.g. dormitory) on a temporary and reserved basis and centralized facilities associated with such accommodation or programs, or for the provision of administration or dining. An institutional camp may include accessory *buildings*, *structures* or facilities incidental to the *principal use*, such as common washrooms, recreational facilities, dining facilities or *retail* sales;

“interior side parcel line” means a *parcel* line between two or more *parcels* other than the front, rear or *exterior side parcel line*;

“interpretive centre” means a *building* that provides interpretation of a place of interest related to the natural environment through a variety of media, such as video displays, information panels and exhibitions of material, and which may also include accessory facilities such as a refreshment stand or gift shop.

K

“kennel” means the care of five (5) or more dogs, cats or other domestic animals or pets whether such animals are kept commercially for board, propagation, training, sale or for personal and private enjoyment;

L

“lane” means a *highway* that provides a secondary access to one or more *parcels* and is less than 8.0 metres in width;

“**livestock**” means horses, cattle, sheep, swine, llamas, *ratites*, goats, farmed game and other similar animals;

M

“**manufactured home**” means a *mobile home* or *modular home* normally built in an enclosed factory environment in one or more sections, intended to be occupied in a place other than that of its manufacture, but excludes travel trailers, *recreational vehicles*, park model *recreational vehicles* or campers;

“**manufactured home park**” means any parcel of land, upon which three (3) or more *manufactured homes* or *single detached dwellings* are located on individual *manufactured home* sites that are occupied exclusively for *residential* purposes on a rental basis. Includes all *buildings* and *structures* used or intended to be used as part of such *manufactured home park*;

“**manufactured home space**” means an area of land for the installation of one *manufactured home* with permissible additions and situated within a *manufactured home park*;

“**manufacturing**” means fabricating, processing, assembling and finishing of goods or materials as well as the processing of produce, meat or beverages but excludes the use, processing or production of hazardous wastes;

“**marina**” means a commercial or government establishment or premise, containing multi-berth docking facility where more than two (2) boats or other vessels are berthed or stored, or where any number of watercraft are serviced, constructed or kept for sale or rent. Accessory facilities for the sale of marine fuels and lubricants, eating and drinking establishment, boating accessory retail sales and wastewater pumping facilities may also be provided;

“**metal storage container**” means a purpose-designed metal cargo container for holding of goods, which is intended to be placed on a ship, truck or railcar;

“**minimum parcel size**” means the minimum area of a *parcel* of land that can be created by subdivision;

“**mobile home**” means a *manufactured home* which is certified as being constructed to the Canadian Standards Association Z240 Mobile Home Series Standard;

“**mobile vendor**” means a vehicle intended to be moved from location to location, for the purpose of offering for sale food or retail products;

“**modular home**” means a *manufactured home* which is certified as being constructed to the Canadian Standards Association A277 Standard and is designed to be moved once onto a permanent, full perimeter foundation;

“**moorage**” means the tying, fastening or securing of a boat or other watercraft to a *dock*;

“motel” means a *building* or *buildings* containing housekeeping and/or not less than six (6) *sleeping units* each with an exterior entrance and designed to provide temporary accommodation for the travelling public;

“mural” means an artistic rendering or drawing painted or otherwise applied to a *building* face which is intended as a public display and does not include an advertising content, but does not include *fascia sign*;

N

“natural boundary” means the visible high watermark of any lake, river, stream, or other body of water where the presence and action of the water are so common and usual and so long continued in all ordinary years as to mark upon the soil of the bed of the lake, river, stream, or other body of water a character distinct from that of the banks, in vegetation, as well as in the nature of the soil itself;

“natural resource extraction” means the quarrying, sorting, screening, removal and off-site sale of sand, gravel, earth or mineralized rock found on or under a site and includes quarries, gravel pits, *gravel processing* and stripping of topsoil but excludes subsequent *manufacturing* operations such as concrete and *asphalt plants*;

O

“off-farm products” means *farm products* that are not grown, reared, raised or produced on the farm from which they are being sold;

“office” means a business premises or *building*, designed, intended and used for the provision of professional, management, administrative, government, consulting, or financial services in an office setting including but not limited to the offices of: lawyers, accountants, travel agents, real estate and insurance firms, planners, non-government organizations, clerical agencies, Crown corporations, municipalities and provincial or federal governments;

“outdoor market” means a temporary use where groups of individual sellers offer new and used goods, crafts or produce for sale directly to the public;

“outdoor recreation” means a facility used and equipped for the conduct of outdoor sports, leisure and entertainment activities, instructional courses and equipment rentals and may require amenities such as showers and storage, but excludes equestrian centres and *golf course*;

“outdoor storage” means the storage of equipment, goods, and materials in the open air where such storage of goods and materials does not involve the erection of permanent *structures*. Typical uses include but are not limited to vehicle or heavy equipment storage compounds; and the sale, rental and storage of metal shipping containers;

P

“**panhandle**” means any *parcel* with any of the *building* envelope situated directly behind another *parcel* so that its frontage is a relatively narrow strip of land which is an integral part of the *parcel*;

“**parcel**” means any parcel, block or other area in which land is held or into which it is subdivided whether under the *Land Title Act* or the Bare Land Strata Regulations under the *Strata Property Act* or a legally recorded lease of license of occupation issued by the Province of British Columbia;

“**parcel coverage**” means the total horizontal area of *structures* measured to the outside of the exterior walls of the *buildings* and *structures* on a lot including the horizontal areas of attached decks and porches, expressed as a percentage of the lot area, and for a *structure* with no defined exterior wall, measured to the drip line of the roof or, in the case of decks and porches, includes the horizontal flooring area;

“**parcel depth**” means the mean horizontal distance between the *front parcel line* and *rear parcel line* of any *parcel*;

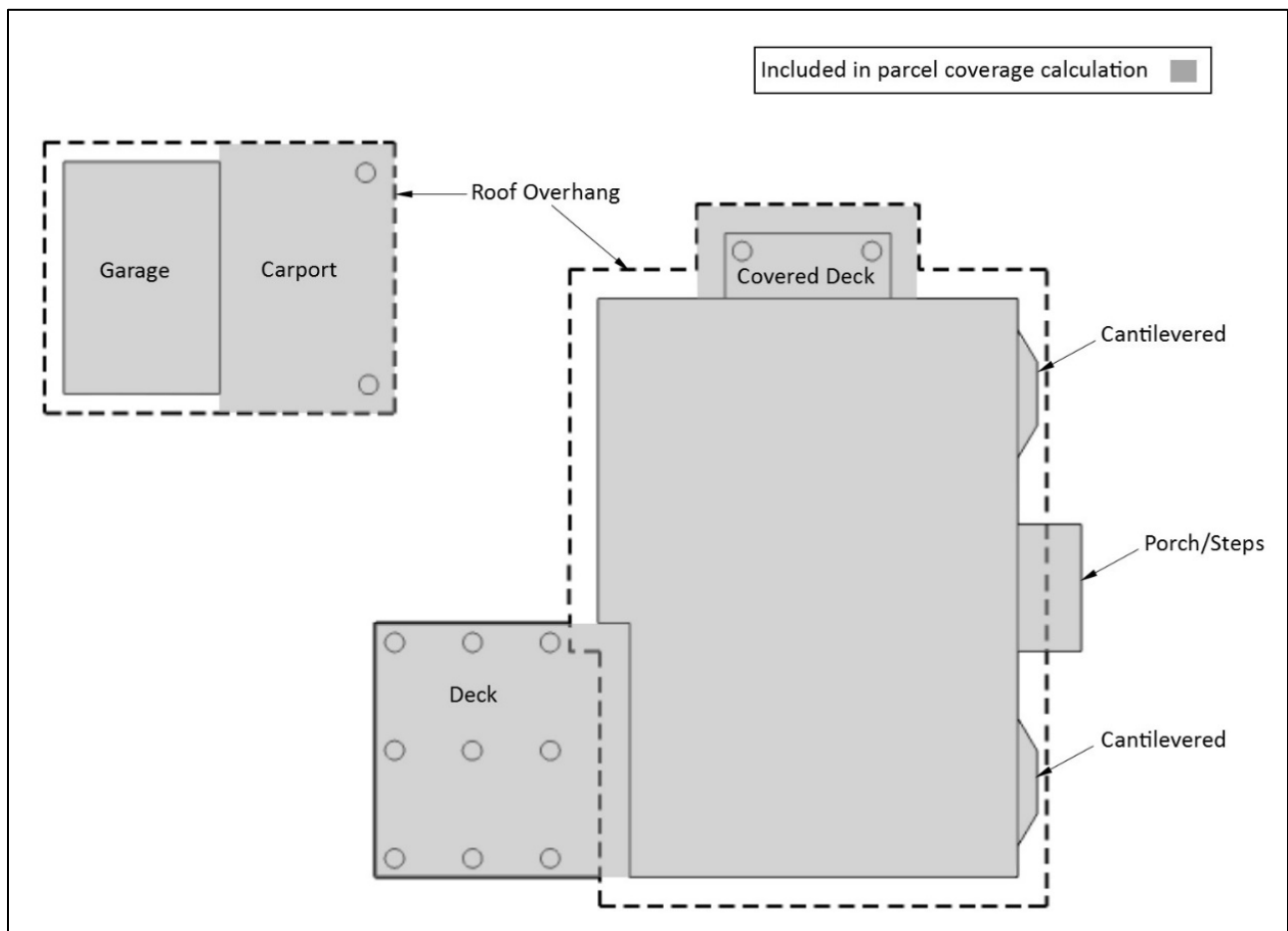

Figure 1 — Parcel Coverage Illustration

“**parcel size**” means the area of land within the boundaries of the lot but excludes an access strip associated with a *panhandle parcel*;

“parcel width” means the mean horizontal distance between the side *parcel* lines of any *parcel*;

“park” means any publicly-owned, held or beneficially owned outdoor land or facility specifically designed for passive or active recreation including tot-lots, playgrounds, walkways, trails, band shells, greenbelts, buffers, nature interpretation areas, or similar land uses, including all uses permitted in Provincial Parks, and all natural and constructed landscaping, facilities, playing fields, *buildings* and *structures* consistent with the general purpose of public park land;

“personal service establishment” means a commercial service intended to serve the health, grooming, financial, recreational, athletic activities or related well-being of an individual;

“poultry” means domestic fowl and pigeons including any bird in captivity but excludes *ratites*;

“principal building” means the *buildings* and *structures* intended for the *principal use* of a *parcel*, as listed under the principal permitted uses of the applicable zone;

“principal dwelling unit” means a principal *residential dwelling unit* that is not a *secondary suite* or *accessory dwelling*.

“principal use” means the main purpose for which a *parcel*, *building* or *structure* is used;

“processed farm products” means *farm products* that have been transformed by biological or other means such as fermentation, cooking, butchering, canning, smoking or drying to increase their market value and convenience to the consumer, but excludes hot and cold food items sold for on-site consumption;

R

“range grazing” means the feeding on grass or pasture of *livestock*;

“ratites” means a bird having small or rudimentary wings and no keel to the breastbone, includes ostriches, emus, and rheas;

“rear parcel line” means the boundary of a *parcel* which lies the most opposite to the *front parcel line* and, where the property has only three *parcel* lines, the rear of the *parcel* is the point where of the two side *parcel* lines meet;

“recreational vehicle” means a vehicle designed to be towed behind a motor vehicle or self-propelled, and includes such vehicles commonly known as travel trailers, fifth wheels, camper trailers, pick-up coaches, motorized campers, motorized homes, park model trailers and other similar vehicles, including vehicles constructed to the Canadian Standards Association Z240 RV and Z241 Standards, which provide temporary recreational accommodation for the traveling public;

“refuse disposal site” means an area of land for the disposal of municipal solid waste, as permitted under the *Environmental Management Act (British Columbia)*;

“residential” means the occupancy or use of a *dwelling unit* for the permanent domicile of a person or persons; or the occasional or seasonal occupancy of a *dwelling unit* as a dwelling by an owner who has a permanent domicile elsewhere or by non-paying guests of such an owner, but excludes *vacation rental*;

“retail sales of farm products” means *retail* activity which is accessory to a *farm use* and which may include the sale of goods produced on that farm as permitted in a given zone and which includes *buildings* and *structures* necessary for the sale and storage;

“retail” means premises where the sale of goods to the final consumer, but excludes gasoline, heavy agricultural or industrial equipment, or any goods stored outside and *convenience store*;

“retaining wall” means a *structure* or series of interdependent *structures* greater than 1.2 metres in *height* constructed to hold back, stabilize or support an earthen bank;

S

“salvage operation” means a place where old articles, waste or discarded material including but not limited to rubber tires, metal, plastics, plastic containers, glass, papers, sacks, wire, ropes, rags, machinery, cans, any other scrap or salvage including more than two *derelict vehicles*, are stored or kept, for private or commercial purposes;

“scientific research facilities” means *buildings and structures* used for scientific research, investigation, testing or experimentation;

“screen” means a *fence*, wall or hedge used as an enclosure and a visual barrier about all or part of a *parcel*, broken only for driveways and walkways;

“secondary suite” means a second *dwelling unit* that is located entirely within a *single detached dwelling*, a *duplex dwelling* or a *townhouse* and that is clearly accessory to the *principal dwelling unit*, with direct access to the open air without passage through any portion of the *principal dwelling unit*;

“self-storage” means a self-contained *building* or group of *buildings* containing lockers available for rent for the storage of personal goods or a facility used exclusively to store bulk goods of a non-hazardous nature;

“service industry establishment” means a business premises or *building*, where non-personal goods and services are provided, including: the repair or assembly of electronic devices, vehicles, trucks, boats or other machinery (including painting); tire sales and repair; household cleaning and repair; metal and woodworking; plumbing and heating sales; storage and repair;

“service station” means premises used principally for the *retail* sale of motor fuels, lubricating oils, propane and motor vehicle accessories, *retail* sales by way of vending machines and the servicing

of motor vehicles, but excludes other *retail* sales, wholesale sales, or motor vehicle structural body repairs and painting;

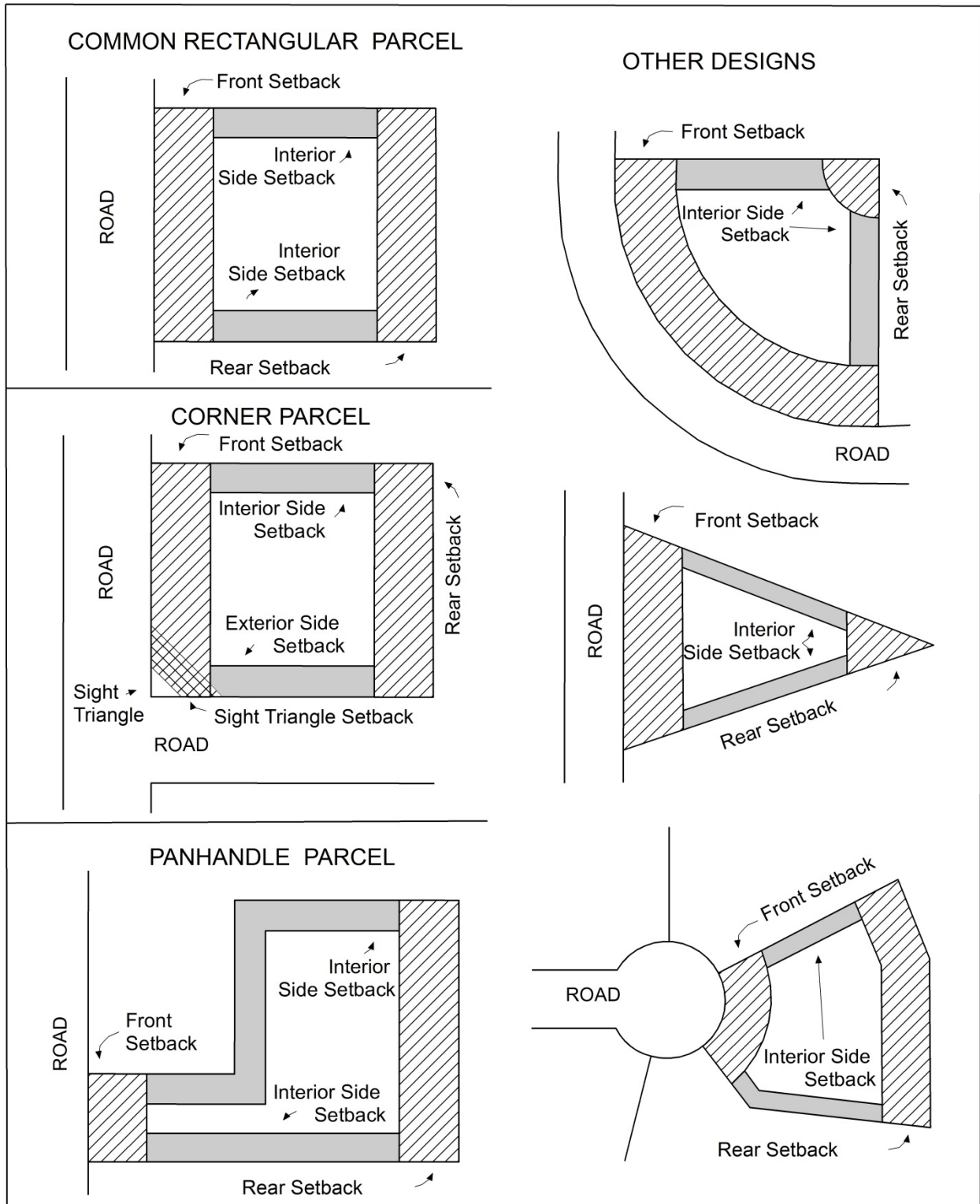

Figure 2 — Setback Areas

“setback” means the horizontal minimum permitted distance measured at right angles to a *parcel* line, between the *parcel* line and a *building* or *structure*, or, in the case of *floodplain* or a *watercourse*, distance measured from the *natural boundary*, top of bank or other reference identified elsewhere in this Bylaw;

“setback, front” as illustrated in Figure 2, means the minimum required *setback* area between the side *parcel* lines extending from the *front parcel line* to the nearest wall or supporting member of a *building* or *structure*;

“setback, rear” as illustrated in Figure 2, means the area between the side *parcel* lines extending from the *rear parcel line* to the nearest wall or supporting member of a *building* or *structure*;

“setback, side” as illustrated in Figure 2, means the area of the *parcel* which extends from the front *setback* to the rear *setback*, between the side *parcel* line and the nearest wall or supporting member of a *building* or *structure*;

“sight triangle” means the area formed by intersecting *parcel* lines at a street corner and a line joining points on the *parcel* measured 4.5 metres from the point of intersection of the *parcel*;

“sign” means any object, device, display, *structure*, or part thereof, which is used to advertise, identify, display, direct or attract attention to an object, service, event or location by any means including words, letters, figures, design, symbols, fixtures, colours, illumination or projected images;

“single detached dwelling” means a detached *building* that contains one *dwelling unit* used for *residential* use by one *family* and may contain a *secondary suite* if permitted in the applicable zone, and includes a *modular home* but excludes a *mobile home*;

“sleeping unit” means one or more habitable rooms used or intended to be used for sleeping or sleeping and living purposes, but excludes *cooking facilities*;

“small livestock” means *poultry*, rabbit or other small animals similar in size and weight but excludes farmed fur bearing animals or roosters;

“solid screen” means a solid *fence* or wall used as an enclosure and a total visual barrier about all or part of a *parcel* and includes gates on all access points made of materials comparable to the *fence* or wall;

“standard dykes” means dykes built to a minimum crest elevation equal to the flood construction level, which meet standards of design and construction approved by the Province and which are maintained by an ongoing entity such as a local government body;

“stockyard” means a *building* or enclosure with pens or sheds for housing, buying, selling and auctioning *livestock*;

“storage and warehouse” means the storage and distribution of goods, wares, merchandise, substances, articles or things, whether or not the storage is contained in separately occupied, secured storage areas or lockers;

“structure” means any construction fixed to, supported by or sunk into land or water, and includes swimming pools, *retaining walls* and *manufactured home spaces*, but excludes *fences* under 2.0 metres in *height*, landscaping, paving and signs unless otherwise noted in this bylaw;

T

“third party advertising sign” means a sign which directs attention to a business, commodity, service, or entertainment which is conducted, sold, or offered elsewhere than on the *parcel* on which the sign is located, including billboards;

“tourist accommodation” means a *building* or *buildings* providing temporary accommodation for the travelling public, such as *tourist cabins*, lodges, *motels*, *hotels*, inns, or hostels, which may include common public facilities, such as an *eating and drinking establishment*, gift shop; personal services, or spa; but shall excludes *vacation rental*, *recreational vehicles*, park model trailers or *mobile homes*;

“tourist cabin” means a detached *building* containing a maximum of one *sleeping unit* used exclusively for *tourist accommodation*, and may include washroom facilities;

“townhouse” means a *building* not more than three storeys high divided into three or more *dwelling units* located side by side under one roof with private entrances to each *dwelling unit* from the exterior of the *building* and with each *dwelling unit* sharing common walls;

U

“useable parcel area” means all the area of a *parcel* except areas that are:

- a) the narrow strip of land that provide frontage for a *panhandle parcel*;
- b) required as *building setbacks* from property lines;
- c) required as *building setbacks* from *watercourses* or geotechnical hazards such as steep or unstable slopes; and
- d) subject to a restrictive covenant that prohibits all use of the area subject to the covenant.

“utility use” means the use of land for the establishment of facilities and associated appurtenances for the provision of water, sewer, electrical, natural gas, communication, fire protection and transportation; but excludes oil or gas storage tanks; power sub-stations; sewage treatment plants; *offices*; or public storage or maintenance and works yards;

V

“vacation rental” means the use of a *residential dwelling unit* for the temporary commercial accommodation of paying guests for a period of less than one month, but excludes a *bed and breakfast operation*;

“vehicle sales and rentals” means premises used for the sale, lease or hire of new or used vehicles, which may include accessory incidental maintenance services, storage, fueling, washing and sales of parts but may not include automobile body repair. For the purposes of this definition a “vehicle” includes automobiles, *recreational vehicles (RV’s)*, boats, all-terrain vehicles (ATV’s), and motorcycles;

“veterinary establishment” means a use conducted for the care, treatment, or hospitalization of animals, birds and fish and may include grooming facilities and sales of accessory supplies, but excludes the keeping or boarding of animals not under care, treatment or hospitalisation;

W

“watercourse” includes any of the following: a watercourse, whether it usually contains water or not; a pond, lake, river, creek or brook, and; a ditch, spring or wetland that is connected by surface flow to a watercourse;

“wet bar” means an area within a dwelling unit, other than a cooking facility, used for the preparation of beverages. A wet bar includes one single sink, one compact refrigerator, freezer or ice maker and no more than 1.5 metres of counter and lower cabinet space, but excludes a natural gas or 220-volt connection in the same room as a wet bar;

“winery” means the use of land, *buildings* or *structures* involved in the manufacturing, packaging, storing and sales of grape and fruit-based wines, including a wine bar, food & beverage lounge and an *eating and drinking establishment*; and

“wholesale business” means an establishment acting as agents or brokers and buying merchandise for, or selling merchandise to *retail* users, industrial users, commercial users, institutional users or wholesale users.

5.0 CREATION OF ZONES

5.1 Zoning Districts

For the purposes of this Bylaw, the area of the Regional District subject to this Bylaw is hereby divided into zoning districts with the following zone designations and their abbreviations. The headings below create categories of zones and represent all the zones under that heading:

Resource Area Zones		Commercial Zones	
Resource Area	RA	General Commercial	C1
Watershed Resource Area	WRA	Service Commercial	CS1
Agriculture Zones		Tourist Commercial Zones	
Agriculture Three	AG3	Tourist Commercial	CT1
		Campground Commercial	CT2
Large Holdings Zones		Golf Course Commercial	CT3
Large Holdings One	LH1	Industrial Zones	
Large Holdings Two	LH2	General Industrial	I1
Small Holdings Zones		Heavy Industrial	I2
Small Holdings One	SH1	Administrative and Institutional Zones	
Small Holdings Two	SH2	Administrative and Institutional	AI
Small Holdings Three	SH3	Parks & Natural Environment Zones	
Small Holdings Four	SH4	Parks and Recreation	PR
Low Density Residential Zones		Conservation Area	CA
Low Density Residential One	RS1	Comprehensive Development Zones	
Low Density Residential Manufactured Home Park	RSM1	Elkhart Lodge Comprehensive Dev.	CD3
		Kennedy Lake Comprehensive Dev.	CD6

5.2 Definition of Zones

The area of each zone is defined by Schedule '2'.

5.3 Interpretation

Except as expressly provided in this Bylaw, all headings, italicized clauses and other references forming part of this Bylaw must be construed as being inserted for convenience and reference only.

5.4 Permitted Uses

In respect of each zone created under Section 5.1 of this Bylaw:

- .1 the only uses permitted are those listed in respect of each zone under the heading “Permitted Uses” in Sections 12.0 to 22.0 of this Bylaw; and
- .2 uses not listed in respect of a particular zone are prohibited.

5.5 Conditions of Use

On a particular site in a specified zone created under this Bylaw, the maximum permitted *parcel coverage, height* and density and the minimum required *setbacks* are set out in respect of each specified zone in the provisions found in Sections 12.0 to 22.0 of this Bylaw.

5.6 Parcels Divided by Zone Boundary

Where a *parcel* is included in more than one zone, the zone boundary as shown on the map accompanying and forming part of this Bylaw shall be deemed to be a *parcel* boundary for the purposes of determining applicable uses, *parcel size*, densities and/or regulations other than *building setbacks* contained in this Bylaw.

5.7 Comprehensive Development Zones

A Comprehensive Development (CD) Zone shall only be created where a proposed *development* is of a scale, character, or complexity requiring comprehensive planning and implementation that, in the opinion of the Regional District Board, is of a unique form or nature not contemplated or reasonably regulated by another zone.

6.0 GENERAL REGULATIONS

6.1 Cannabis Production

Where *agriculture* is permitted in a zone, *cannabis production, indoor* is permitted subject to the following regulations:

- .1 the land is designated as Agricultural Land Reserve (ALR) and the use is as a designated *farm use* under Section 8 of the *Agricultural Land Reserve Use Regulation*.
- .2 the *structure* has a base consisting entirely of soil is a *structure* that shall not have concrete construction, hardsurfacing or similar impermeable forms of construction sunk into, at or below the natural elevation of a site, except:
 - a) a *building* or *structure* supported by a system of columns or posts, where:
 - i) each supporting column or post has a minimum radius of 3.0 metres to the next adjacent column or post; and
 - ii) the maximum footprint area for each concrete footing associated with each column or post is 0.5 m².

6.2 Fence Heights

The *height* of a *fence* shall be determined by measurement from the ground level, at the place on which the *fence* is to be located, to the top of the *fence*.

- .1 No *fence* shall exceed 1.8 metres in *height* to the rear of a front *setback* and 1.2 metres in *height* in the front *setback* except:
 - a) in the Resource Area, Agriculture, Large Holdings and Small Holdings zones all *fences* may be up to 1.8 metres in *height*, and in the Industrial zones all *fences* may be up to 2.4 metres in *height*;
 - b) in Commercial zones abutting or across a *highway* from the AG1, AG2 & AG3 zones all *fences* may be up to 2.0 metres in *height*;
 - c) in the case of a *fence* constructed on top of a *retaining wall*, the combined *height* of the *fence* and the *retaining wall* at the *parcel* line or within 1.2 metres of the *parcel* line shall not exceed 1.8 metres in *height*, as measured from the *finished grade* of the abutting higher *parcel*;
 - d) deer *fences* shall not be limited in *height*, provided such *fences* are constructed of material that permits visibility, such as wire mesh or wire strand, but excluding chain link; and
 - e) *fences* for ball *parks* and tennis courts shall not be limited in *height*, provided such *fences* are constructed of materials that permit visibility, such as wire mesh.
- .2 The use of barbed wire for fencing is prohibited within all Residential and Commercial zones as well as the AI Zone.
- .3 The use of razor wire for fencing is prohibited within all zones.

6.3 Fuel Storage and Distribution

- .1 In the Low Density Residential zones, the placement and maintenance of fuel storage tanks exceeding 50 litres is prohibited, except where the tank is used only for storing heating fuels; and
- .2 All fuel distribution pumps or devices shall be located a minimum of 3.5 metres from any parcel line.

6.4 Height Exemptions

- .1 No part of a *building* or *structure* shall extend beyond a *height* limit required by this Bylaw except the following minor projections on *buildings*:
 - a) antennas, belfries, chimney stacks, church spires, clearance markers, elevator shafts, flagpoles, monuments, rooftop mechanical equipment, ventilation machinery and water tanks.

6.5 Keeping of Livestock and Honeybees

In this Bylaw, where *single detached dwelling* is a permitted use the following regulations apply:

1. the number of *livestock*, *small livestock* and honeybee hives permitted per *parcel* shall be limited as follows:

PARCEL AREA	MAXIMUM NUMBER OF LIVESTOCK	MAXIMUM NUMBER OF SMALL LIVESTOCK	MAXIMUM NUMBER OF HONEYBEE HIVES
Less than 625 m ²	0	0	0
625 m ² to 2,500 m ²	0	5	2
2,500 m ² to 0.4 ha	0	25	Not applicable
0.4 ha to 1.0 ha	2	50	Not applicable
1.0 ha to 1.5 ha	3	75	Not applicable
1.5 ha to 2.0 ha	4	100	Not applicable

2. On *parcels* 2,500 m² or greater in area, keeping of honeybees shall be unlimited, and on *parcels* 2.0 ha or greater in area, keeping of *livestock* and *small livestock* shall be unlimited.
3. Products derived from the keeping of *livestock* and honeybees may be sold in accordance with Section 7.6 (Home Industry) of Section 7.7 (Home Occupation) of this bylaw, in addition to any applicable provincial regulations.
4. Honeybee hives must be located in accordance with the following:
 - a) to the rear of the *principal dwelling unit*; and
 - b) 7.5 metres from any *parcel* line, unless the underside of the hive is situated:

- i) greater than 2.5 metres above the adjacent ground level, in which case the *setback* from any *parcel* line shall be 2.0 metres; or
- ii) less than 2.5 meters above the adjacent ground level, in which case the *setback* from any *parcel* line shall be 2.0 metres provided the beehive is situated behind a solid *fence* or hedge more than 2.0 metres in *height* running parallel to any property line and extending at least 6.0 metres beyond the hive in both directions.

6.6 Metal Storage Containers

- .1 The use of *metal storage containers* as accessory buildings or structures is permitted in all zones.

6.7 Mobile Vendor

- .1 A *mobile vendor* is permitted as an accessory building or structure in the Agriculture, Commercial, Tourist Commercial, Industrial and Parks and Recreation (PR) zones.
- .2 despite Section 6.7.1, for parcels situated within the Agricultural Land Reserve (ALR), a “mobile vendor” is permitted only to the extent that a “non-farm use” approval from the Agricultural Land Commission (ALC) has been granted.

6.8 Occupancy of an Existing Dwelling During Construction of a New Dwelling

- .1 Despite a zoning regulation allowing only one *single detached dwelling* on a *parcel*, the Regional District may issue a building permit for a new *single detached dwelling* on the same *parcel* as an existing occupied *single detached dwelling* if the Owner first:
 - a) grants and registers a statutory covenant on title, in a form satisfactory to the Regional District, by which the owner covenants and agrees to the following:
 - i) to demolish and remove, make uninhabitable or move from the parcel the existing *single detached dwelling* in accordance with a “Decommissioning Plan”; and
 - ii) that the decommissioning of the *dwelling* be completed within ninety (90) days of receiving final inspection for the new *single detached dwelling*; or within a time limit stated in the statutory covenant, whichever time comes first.
- .2 In order to qualify for consideration under sub-section .1, a parcel must have a minimum parcel size of 0.5 ha.

6.9 Prohibited Uses of Land, Buildings and Structures

- .1 The use of land in contravention of the terms or conditions of a Temporary Use Permit that has been issued under Section 493 of the *Local Government Act* is prohibited.
- .2 The *residential* use of a tent or *recreational vehicle* is prohibited in all zones.

- .3 The *residential* use of a *recreational vehicle* prohibited in all zones except the RA, LH1, LH2, SH2, SH3, SH4 and CD6.
- .4 The wrecking, salvage or storage of more than two *derelict vehicles* or the use of land as a *salvage operation* is prohibited in all zones except the General Industrial (I1) and Heavy Industrial (I2) zones.

6.10 Recreational Vehicles

- .1 Despite Section 6.9.2, a *recreational vehicle* is permitted to be used for residential purposes in lieu of a principal dwelling in the RA, LH1, LH2, SH1, SH2, SH3 and CD6 zones provided that:
 - a) the *recreational vehicle* shall be connected to an approved sewage disposal system; and
 - b) the *recreational vehicle* shall meet the siting regulations specified in the applicable zone.
- .2 The following additions to recreational vehicles are permitted:
 - a) roof shelters.
- .3 Where a *recreational vehicle* is not permitted in lieu of a principal dwelling, only *recreational vehicles*, to a maximum of one (1), belonging to the owner or occupier of a principal *single detached dwelling* on a *parcel* may be stored or parked on the same *parcel*. Stored *recreational vehicles* shall not be connected to a sewage disposal system, water system or power source.
- .4 Despite Section 6.9.2, one (1) *recreational vehicle* belonging to a guest or visitor of the owner or occupier of the principal *single detached dwelling* may be located on the same *parcel* containing the principal *single detached dwelling* provided that:
 - a) the *recreational vehicle* shall only be used for the temporary accommodation of the guest or visitor;
 - b) the temporary accommodation shall not exceed a total of ninety (90) days in any one (1) calendar year.
- .5 Despite Section 6.9.2, a *recreational vehicle* may be maintained and occupied on a *parcel* during the construction of a new *single detached dwelling* on the same *parcel*, subject to the following:
 - a) it is incidental to the construction of a principal *residential building*;
 - b) the *building* or *structure* must have a valid building permit;
 - c) it meets the siting regulations of the zone in which it is located; and
 - d) it is removed within thirty (30) days of the completion of the construction of the principal *residential building*.

6.11 Residential Density Calculation

In zones where a maximum number of *residential* units per hectare is permitted, the density shall be determined as follows:

$$(\text{permitted density} \div 10,000) \times \text{parcel area} = \text{permitted number of units}$$

The value of this product shall be rounded down to the nearest whole number of units.

6.12 Retaining Walls

1. the *height* of a *retaining wall* shall be determined by measurement from the lowest *finished grade* at the base of the *retaining wall* to the top of any part of the *retaining wall*.
2. the minimum horizontal distance between individual *retaining walls* on the same *parcel*, as measured from the outer face of each *retaining wall*, must not be less than the *height* of the lowest *retaining wall*.
3. *retaining walls* constructed closer than the *height* of the lowest *retaining wall* will collectively be considered a single *retaining wall* for the purposes of determining the *height* of a *retaining wall*.
4. no *retaining wall* shall exceed 2.0 metres in *height* except:
 - a) in a required *setback* for a *front parcel line*, *side parcel line* or *rear parcel line* no *retaining wall* shall exceed 1.2 metres in *height*; and
 - b) on a corner site contiguous to a *highway* intersection, no *retaining wall* is permitted within a distance of 4.5 metres from the corner of the site at the intersection of the streets.
5. despite sub-section 6.12.4(a), a *retaining wall* in a required *setback* for a *front parcel line*, *side parcel line* or *rear parcel line* may be 2.0 metres in *height* where the *finished grade* of the subject *parcel* at the base of the *retaining wall* is lower than the *finished grade* of the abutting *parcel* or *highway*.
6. despite sub-section 6.12.4(b), a *retaining wall* is permitted within 4.5 metres of a corner site contiguous to a *highway* intersection where the *finished grade* of the subject *parcel* at the base of the *retaining wall* is lower than the *finished grade* of the abutting *highway*, and provided no part of the *retaining wall* extends above the *finished grade* of the abutting *highway*.

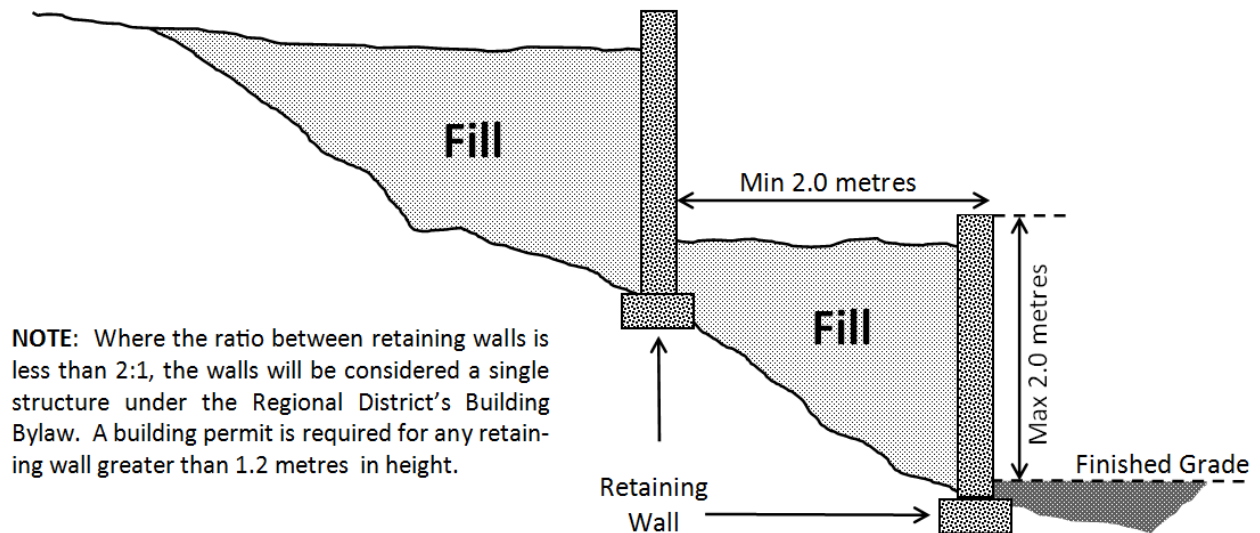

Figure 3 - Retaining Wall Illustration

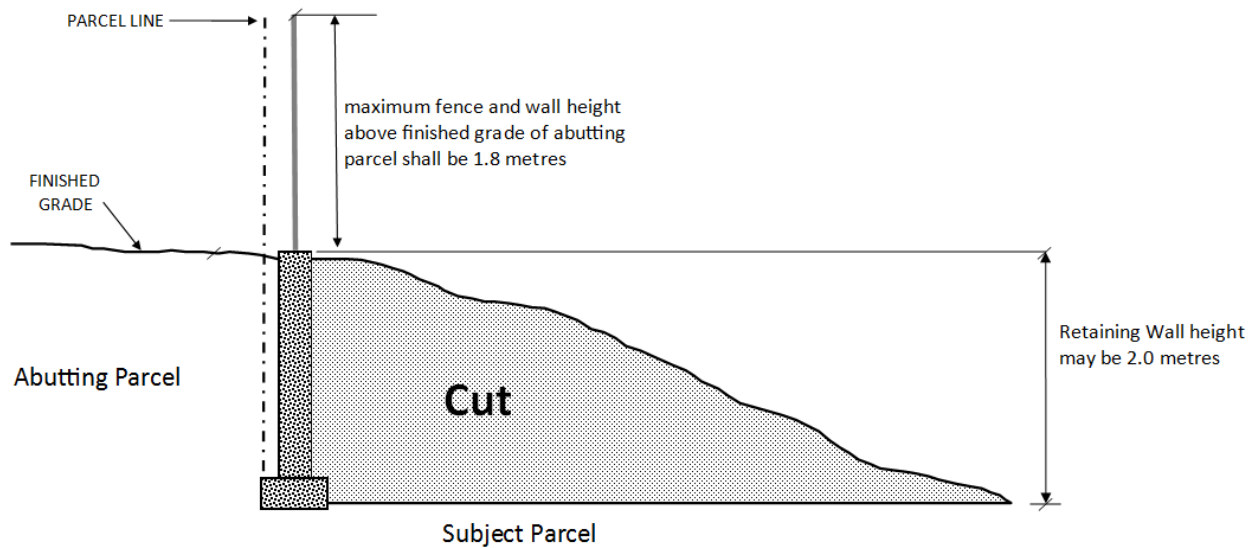

Figure 4 - Retaining Wall in a Setback Illustration

6.13 Setback Exemptions

- .1 No part of any *building* or *structure* shall project into a *setback* required by this Bylaw except the following minor projections on *buildings*:
 - a) Gutters, eaves, sunshades, cornices, belt courses and sills may project into required *setbacks* to a maximum of 0.6 metres measured horizontally;
 - b) Unenclosed access ramps for physically disabled persons may project fully into required *setbacks*;
 - c) In the Low Density Residential zones the following features may project into the required *setbacks*:

- i) chimneys, bay windows or other architectural projections which do not comprise more than 25% of the total length of a wall and do not project more than 0.6 metres measured horizontally; and
- ii) unenclosed stairwells, balconies, porches, uncovered decks or canopies, may project no more than:
 - .1 front *setback*: 1.5 metres, measured horizontally
 - .2 rear *setback*: 2.0 metres, measured horizontally
- iii) roof mounted *solar energy devices* to a maximum of 1.0 meter above the maximum *height* allowed for the *building or structure* on which it is installed.
- d) In no case shall a projection cross a *parcel* line.
- .2 Freestanding clothes line poles, antennas, masts, utility poles, flagpoles, open roof pergolas and children’s play equipment are permitted anywhere on a *parcel*.
- .3 Despite any other provisions of this Bylaw, all *structures* shall be set back from the international boundary between Canada and the United States in accordance with the *International Boundary Commission Act (Canada)*.

6.14 Uses Permitted in Every Zone

The following uses are permitted in every zone and are not subject to any minimum *parcel* area requirements of any zone:

- .1 Government controlled, held or sanctioned *parks*, playfields and playgrounds open to the public;
- .2 *utility uses*;
- .3 roads and *lanes*;
- .4 *conservation area*;
- .5 fire halls, police stations, ambulance service uses, and similar emergency services;
- .6 facilities permitted by provincial enactment for:
 - a) day care for no more than eight (8) persons in care, or
 - b) residence for no more than ten (10) persons, not more than six (6) of whom are persons in care.
- .7 Provincial, municipal, and regional improvement district works for flood control.

6.15 Visibility at Intersections

- .1 In all zones, no *fence*, landscaping, *retaining wall*, or other obstruction shall be erected or permitted at a *height* greater than 1.0 metre above the established elevation of the centre point of intersecting *highways* within a sight triangle, at or within a distance of 4.5 metres from the corner of the *parcel* at the intersection of the *highway*.

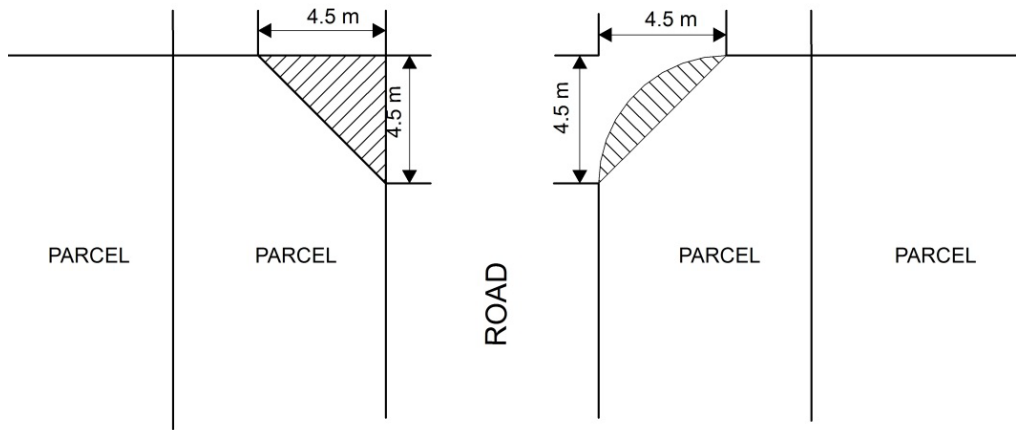

Figure 6 – Sight Triangle

7.0 SPECIFIC USE REGULATIONS

7.1 Accessory Buildings and Structures

- .1 A *building or structure*, other than a *building or structure* containing one or more *dwelling units*, attached to a *principal building* is deemed to be a portion of the *principal building* if attached by a common wall and roof.
- .2 No *accessory building or structure* shall contain showers and bathtubs, bedrooms, sleeping facilities, balconies, decks or wet bars with the exception of an *accessory building or structure* in the Resource Area, Agriculture and Large Holdings Zones in which case one (1) shower is permitted, with a maximum floor area of 3.0 m².
- .3 The maximum number of bathrooms permitted in an *accessory building or structure* shall be one (1) and shall not exceed a maximum floor area of 3.0 m², with the exception of an *accessory building or structure* in the Resource Area, Agriculture and Large Holdings Zones where the maximum floor area of a bathroom may be 6.0 m².
- .4 No *accessory building or structure* shall be situated on a *parcel* unless:
 - a) a *principal building* has already been erected on the same lot;
 - b) a *principal building* will be erected simultaneously with the *accessory building or structure* on the same lot; or
 - c) the *accessory building or structure* does not exceed 10.0 m² in area, one storey in *building height*, and is limited to one (1) per *parcel*.

7.2 Accessory Dwellings

The following regulations apply to *accessory dwellings* where permitted as a use in this Bylaw:

- .1 An *accessory dwelling* shall not be permitted on *parcels* less than 1.0 ha in area unless connected to a community sewer system.
- .2 No *accessory dwelling* shall have a floor area greater than 125.0 m², unless otherwise specified.
- .3 On a *parcel* greater than 1.0 ha in area, an *accessory dwelling* may be in the form of a *mobile home*;
- .4 A parking space for an *accessory dwelling* shall not be provided in tandem with parking spaces provided for any other use on a *parcel*.
- .5 An *accessory dwelling* cannot be subdivided under the *Strata Property Act*.
- .6 In the Commercial, Tourist Commercial and Industrial zones, an *accessory dwelling*:
 - i) shall be located at the rear of a *building* on the ground floor, or above the first storey;
 - ii) shall have a separate entrance from the exterior of the *building* and shall not share a common hallway with commercial, tourist commercial or industrial uses; and

- iii) despite section 7.2.4, may be permitted on a *parcel* less than 1.0 ha in area that is not connected to a community sewer system, if no other *dwelling unit* is situated on the *parcel*.

7.3 Agri-Tourism Accommodation

The following regulations apply to *agri-tourism accommodation* where permitted as a use in this Bylaw:

- .1 *Agri-tourism accommodation* is permitted only on a *parcel* if all or part of the *parcel* is classified as a “farm” under the *Assessment Act*.
- .2 *Agri-tourism accommodation* shall be for short term use by a person up to a maximum stay of 30 consecutive days with 30 days in between any subsequent stay.
- .3 The number of *agri-tourism accommodation sleeping units* permitted *parcel* shall be as follows:

PARCEL AREA	MAXIMUM NUMBER AGRI-TOURISM ACCOMMODATION SLEEPING UNITS
Less than 4.0 ha	0
4.0 ha to 8.0 ha	5
Greater than 8.0 ha	10

- .4 All *agri-tourism accommodation sleeping units* on a *parcel* shall be contained within a single *building*.
- .5 No *agri-tourism accommodation sleeping unit* shall have an area of greater than 30.0 m². A washroom is not included as part of the area of the *agri-tourism accommodation sleeping unit*.
- .6 An *agri-tourism accommodation* use must not include *cooking facilities*, meeting rooms, conference facilities, event space or space for food and alcohol service.
- .7 One (1) parking space per *agri-tourism accommodation sleeping unit* is required in addition to parking required for the principal *single detached dwelling*.

7.4 Bed and Breakfast Operations

A *bed and breakfast operation* is permitted where listed as a permitted use, provided that:

- .1 it is located within one *principal dwelling unit* on the *parcel*;
- .2 no more than eight (8) patrons shall be accommodated within the *dwelling unit*;
- .3 no more than four (4) bedrooms shall be used for the *bed and breakfast operation*;
- .4 no *cooking facilities* shall be provided for within the bedrooms intended for the *bed and breakfast operation*;
- .5 no patron shall stay at the *bed and breakfast operation* for more than thirty (30) consecutive days with 30 days in between any subsequent stay;

- .6 no *retail* sales other than the sale of goods produced on the *parcel* are permitted;
- .7 no commercial vehicle, exceeding 1 tonne in weight, associated with or used in the conduct of the *bed and breakfast operation* shall be parked or otherwise located outside an unenclosed *building*; and
- .8 only persons residing in the *principal dwelling unit* may carry on the *bed and breakfast operation* on the *parcel* occupied by the *principal dwelling unit*, and must be present on the property and residing in the *principal dwelling unit* during a patron's stay.

7.5 Campgrounds

A *campground* is permitted where listed as a permitted use, provided that:

- .1 a campground use shall be connected to a community sewer system and community water system;
- .2 the minimum area on which a campground use may be undertaken shall be 2.0 ha;
- .3 the maximum number of campground units per hectare shall not exceed 75;
- .4 not more than 25% of all campground units within a campground shall be used for the placement of tourist cabins;
- .5 a tourist cabin may not have a gross floor area exceeding 30.0 m² including additions such as covered patios and covered or uncovered decks; and
- .6 a second roadway access from a public highway, separated by at least 50.0 metres from the first access shall be provided to each campground use containing greater than fifty (50) camping spaces.

7.6 Home Industry

The following regulations apply to *home industry* uses where permitted as a use in this Bylaw:

- .1 No *home industry* shall be permitted on a *parcel* less than 2.0 hectares in size.
- .2 The maximum floor area utilized for a *home industry*, including the indoor or *outdoor storage* of materials, commodities or finished products associated with the *home industry* shall not exceed 200.0 m².
- .3 A *home industry* shall only be conducted within an enclosed *building* or *structure*.
- .4 No *retail* sales of products other than the sale of goods produced, grown or assembled on the *parcel* shall be permitted.
- .5 Only persons residing in the *principal dwelling unit* may carry on the *home industry* located on the *parcel*, along with up to two (2) non-resident employees.
- .6 A *home industry* shall not be located on a *parcel* unless a *principal dwelling unit* already exists or is being constructed simultaneously, on the same *parcel*.
- .7 One (1) vehicle parking space per each non-resident employee of a *home industry* use is required in addition to those required for the *principal dwelling unit*.

- .8 A *home industry* shall not involve:
- a) wrecking, salvage or storage of *derelict vehicles* and equipment;
 - b) salvage or storage of used *building* or domestic products and similar discarded materials;
 - c) manufacture of concrete products;
 - d) bulk fuel or chemical storage or refining depots;
 - e) *cannabis production, indoor or outdoor*;
 - f) animal or agriculture products processing; and
 - g) the production of animal feeds.

7.7 Home Occupation

The following regulations apply to *home occupation* uses where permitted as a use in this Bylaw:

1. A *home occupation* shall not occupy more than 40% of the floor area of a *principal dwelling unit* to a maximum of 50.0 m².
2. A *home occupation* shall be carried out within the *principal dwelling unit*, or in an *accessory building or structure* where permitted in the particular zone, with no external storage of materials, containers or finished products.
3. No *retail sales* shall be permitted in a *home occupation*, except for:
 - a) goods produced or made on the premises;
 - b) telephone or internet sales or sales where the customer does not enter the premises;
 - c) mail order sales;
 - d) direct distributors where customers do not enter the premises; and
 - e) sale of products directly related to the *home occupation*.
4. No vehicle exceeding 4,600 kg in vehicle weight and associated with or used in the conduct of a *home occupation* shall be parked or otherwise located outside of an unenclosed *building*.
5. Only persons residing in the *principal dwelling unit* may carry on the *home occupation* located on the *parcel* occupied by the *principal dwelling unit*.
6. One (1) vehicle parking space is required in addition to those required for the *principal single detached dwelling*.
7. A *home occupation* shall not involve:
 - a) material or products that produce inflammable or explosive vapours or gases under ordinary temperatures;
 - b) the *outdoor storage* of materials, vehicles and equipment associated with a contractor, trade or mobile service;

- c) the boarding, breeding and keeping of animals;
- d) *cannabis production, indoor* and *cannabis production, outdoor*;
- e) the salvage or repair of motor vehicles, boats, or other machinery; and
- f) the assembly of more than four (4) persons for any artistic, educational, religious, therapeutic or similar activity.

7.8 Kennel Facilities

A *kennel* is permitted where listed as a permitted use, provided that:

- .1 No *kennel* shall be permitted on a *parcel* less than 4.0 hectares in size, except for a *kennel* located in an Industrial zone;
- .2 All *buildings, structures* and areas utilized in association with a *kennel* shall be sited a minimum of 30.0 metres from all *parcel* lines.

7.9 Retail Sales of Farm Products

- .1 Where *retail sales of farm products* is permitted in a zone, the *retail* sales area for *farm products* shall not exceed 300.0 m².
- .2 For the purpose of calculating the area used for *retail* sales in a *building* or *structure*, the following shall be included:
 - a) aisles and other areas of circulation;
 - b) shelf and display space;
 - c) counter space for packaging and taking payment;
 - d) any area used for the service and consumption of hot and cold food items; and

Any *office* area, wholesale storage area, processing facility or parking area or driveway, whether used for *retail* sale or not, shall be excluded.

7.10 Secondary Suites

The following regulations apply to *secondary suites* where permitted as a use in this Bylaw:

- .1 on *parcels* less than 1.0 ha in area, a *secondary suite* shall be connected to:
 - i) the same on-site septic disposal system that serves the *principal dwelling unit*; or
 - ii) a community sewer system.
- .2 A parking space for a *secondary suite* shall not be provided in tandem with parking spaces provided for any other use on a *parcel*.
- .3 A *secondary suite* must share a common uninterrupted foundation and roof with the *principal dwelling unit* in the *single detached dwelling* and for this purpose garages, *carports* and breezeways are deemed to interrupt a foundation or roof.

8.0 SUBDIVISION REGULATIONS

8.1 Minimum Parcel Size Exceptions for Subdivision

- .1 *Minimum parcel size* for subdivision requirements of this Bylaw do not apply to:
 - a) the consolidation of existing *parcels* or the addition of closed streets to an existing *parcel*;
 - b) the alteration of lot lines between two or more *parcels* where:
 - i) no additional *parcels* are created upon completion of the alteration;
 - ii) the altered lot line does not infringe on the required *setbacks* for an existing *building* or *structure* located on a *parcel*;
 - iii) the alteration does not reduce the site area of the *parcels* involved to a size less than that of the smallest *parcel* that existed prior to the alteration.
 - c) a subdivision approved by the Agricultural Land Commission under its homesite severance policy.
 - d) *building* strata lots authorised pursuant to the *Strata Property Act*.
- .2 No existing *parcel* that meets the present *minimum parcel size* requirements of this Bylaw must, upon completion of a *parcel* line alteration, have a *parcel size* less than that required within the respective zone.
- .3 If a provision in this Bylaw establishes a minimum parcel size of less than 1.0 ha for a new parcel to be created by subdivision, that minimum parcel size only applies to a new parcel that will be connected to community water and sewer systems.

8.2 Minimum Parcel Size Requirements for Bare Land Strata Subdivisions

- .1 The minimum average *parcel size* is equal to the *minimum parcel size* for the designated zoning.

8.3 Minimum Useable Parcel Area

- .1 The minimum *useable parcel area* of each *parcel* shall be 200.0 m².

8.4 Panhandle Parcels

- .1 When a *parcel* is to be in the form of a *panhandle*, the access strip or *panhandle* shall not be included in the calculation of the area of the *parcel* for the purpose of determining compliance with a minimum *parcel* area requirement of this bylaw.
- .2 Despite the minimum *parcel width* provisions for subdivision of this Bylaw, a *panhandle* lot may be created provided that the minimum *parcel width* of the *panhandle* is 8.0 metres and the maximum width shall not exceed 20.0 metres.

- .3 When a *parcel* is to be in the form of a *panhandle*, the minimum *parcel width* requirement shall be calculated for the width of the *parcel* fronting on the extension of the *panhandle*.
- .4 No more than two (2) *panhandle parcels* may be created where the *panhandles* abut each other.

8.5 Hooked Parcels

- .1 A *hooked parcel* may be created where each portion:
 - a) satisfies the minimum *parcel* area requirements of the applicable zone; and
 - b) is separated by a distance not exceeding 30.0 metres.

9.0 SIGNAGE REGULATIONS

9.1 Prohibited Signage

- .1 The following types of signage are not permitted on any *parcel*, *structure* or body of water:
 - a) *animated sign*;
 - b) *electronic changeable copy sign*;
 - c) *illuminated sign*;
 - d) *inflatable sign*;
 - e) *roof top sign*; and
 - f) *third party advertising sign*.

9.2 Commercial, Industrial and Administrative & Institutional Signage

- .1 The following regulations apply to all *signs* advertising a commercial, industrial or administrative and institutional use located on a *parcel*:
 - a) a maximum of two (2) *signs* per *parcel* of the following *sign* types are permitted:
 - i) one (1) *fascia sign*, subject to the following regulations:
 - .1 the maximum *sign* area shall not exceed 25.0 m²; and
 - .2 the *sign* shall only be located on the wall of the *building* containing the business premises to which the *sign* refers.
 - ii) one (1) *freestanding sign*, subject to the following regulations:
 - .1 the maximum *sign* area shall not exceed 5.0 m²;
 - .2 the maximum *height* of a *freestanding sign* shall not exceed 6.5 metres; and
 - .3 no part of any *sign* shall be located within 1.0 metre of a *parcel* line.
 - b) despite Section 9.1.1, a *sign* may be illuminated from an internal source.

9.3 Agricultural Signage

- .1 The following regulations apply to all *signs* advertising the sale of agricultural produce, *livestock* or product grown, raised or produced on the farm:
 - a) a maximum of two (2) *signs* per *parcel* of the following *sign* types are permitted:
 - i) one (1) *fascia sign*, subject to the following regulations:
 - .1 the maximum *sign* area shall not exceed 5.0 m²; and
 - .2 the *sign* shall only be located on the wall of the *building* containing the business premises to which the *sign* refers.

- ii) one (1) *freestanding sign*, subject to the following regulations:
 - .1 the maximum *sign* area shall not exceed 5.0 m²;
 - .2 the maximum *height* of a *freestanding sign* shall not exceed 4.5 metres;
and
 - .3 no part of any *sign* shall be located within 1.0 metre of a *parcel* line.

9.4 Residential Signage

- .1 The following regulations apply to all *signs* advertising a *bed and breakfast operation*, *home industry*, *home occupation* or *vacation rental* use:
 - a) the maximum number of *signs* shall not exceed one (1) per *parcel*;
 - b) only *fascia signs* are permitted; and
 - c) the maximum *sign* area shall not exceed 0.5 m².

9.5 Signage Exemptions

- .1 The following types of *signs* are exempt from the requirements contained in Section 9.2 through to Section 9.4 of this bylaw:
 - a) all signage within a provincial *highway* right-of-way approved by the Ministry of Transportation and Infrastructure (MoTI) under its “Service & Attraction Sign Program”;
 - b) all signage to promote or advertise a political party or candidate from the date of an election call to five (5) days after election day;
 - c) a *mural*;
 - d) real estate *signs* advertising the sale or rental of a *parcel*, a *building* or a unit within a *building* located on a *parcel* on which the *sign* is located, subject to:
 - i) a maximum of one (1) *sign* per *parcel*, *building* or unit being sold or leased;
 - ii) a maximum *sign* area not exceeding 3.0 m²;
 - iii) a maximum *sign height* not exceeding 3.0 metres; and
 - iv) removal of the *signs* within two weeks after the *parcel* or *building* to which the *sign* is related is sold, leased or otherwise taken off the market.

10.0 FLOODPLAIN REGULATIONS

10.1 Floodplain Designation and Flood Construction Level

- .1 The following land is designated as a *floodplain*:
 - a) the area shown as the 200 year *floodplain* for the Similkameen River and the Tulameen River on the floodplain maps attached as Schedule '3' to this Bylaw;
 - b) any land not shown on the provincial floodplain maps that is less than 3.0 metres above the *natural boundary* of the Similkameen River and the Tulameen River;
 - c) any land that is less than 1.5 metres above the *natural boundary* of any other *watercourse*.
- .2 The flood construction level for land designated as a *floodplain* in section 10.1.1 is:
 - a) the 200 year flood levels shown on the provincial floodplain maps for the *floodplain* designated in section 10.1.1(a);
 - b) 3.0 metres above the *natural boundary* for the *floodplain* designated in section 10.1.1(b); and
 - c) 1.5 metres above the *natural boundary* for the *floodplain* designated in section 10.1.1(c).

10.2 Siting Buildings and Structures in Floodplains

Despite any other provisions of this Bylaw, no *building* or *structure* shall be located within:

- .1 7.5 metres of the *natural boundary* of any lake, pond or marsh, or the top of bank where the bank is within 7.5 metres of the *natural boundary* of any lake, pond or marsh; and
- .2 15.0 metres of the *natural boundary* of any other *watercourse*, except the Similkameen River and the Tulameen River; and
- .3 30.0 metres of the *natural boundary* of the Similkameen River and the Tulameen River.

10.3 Measurement of Flood Construction Level

- .1 the flood construction level for a building or structure under 10.1.2(c) is determined by reference to the elevation of the point at which the *natural boundary* of the relevant *watercourse* is closest to any part of the building or structure.

10.4 Floodplain Management Regulations

- .1 No person shall place any structural support for a *habitable area* or fill required to support a *habitable area* on land within a *floodplain setback* area under Section 10.2;
- .2 No person shall construct, reconstruct, move or extend a floor system or pad which supports a *habitable area*, such that the underside of the wooden floor system or the top of the pad or the ground surface on which it is located, is lower than the flood

construction levels specified in Section 10.1 except as provided in Sections 10.4.3 and 10.4.4;

.3 Despite Section 10.4.2, the following *floodplain* management regulations apply:

a) For *Dwelling Units* in the Agricultural Land Reserve:

A *dwelling unit* on a parcel that is 8.0 hectares or greater in area and located within the Agricultural Land Reserve (ALR) shall be located with the underside of any wooden floor system, or the top of the pad of any *habitable area*, or in the case of a *manufactured home* the top of the pad or the ground surface on which it is located, no lower than:

- i) 1.0 metre above the natural ground elevation taken at any point on the perimeter of the *building*; or
- ii) the flood construction levels specified in Section 10.1, whichever is the lesser.

b) For Closed-Sided *Livestock Buildings*:

Closed-sided *livestock buildings* that are not behind *standard dykes* shall be located with the underside of any wooden floor system, or the top of the pad of any *habitable area*, or the ground surface on which it is located, no lower than:

- i) 1.0 metre above the natural ground elevation, taken at any point on the perimeter of the *building*; or
- ii) the flood construction levels specified in Section 10.1, whichever is lesser.

c) For Industrial *Buildings*:

Industrial *buildings*, other than the main electrical power system, must be located with the underside of any wooden floor system or the top of any pad of any *habitable area* or the ground surface on which it is located not lower than the flood construction levels specified in Section 10.1 minus *freeboard*. Main electrical switchgear shall not be lower than the flood construction level.

.4 The *floodplain* management regulations specified in Section 10.4.3 may be achieved by structural elevation of the *habitable area*, or by placing adequately compacted fill on which any *habitable area* is to be constructed or located, or by a combination of both structural elevation and fill.

.5 Where fill is used to meet the *floodplain* management regulations specified in Sections 10.4.2 and 10.4.3, the face of the fill slope must be adequately protected against erosion from flood flows, wave action, ice and other debris hazards.

.6 The following *developments* and uses are excluded from the requirements of the *floodplain* management regulations specified in Sections 10.4.2 and 10.4.3:

- a) renovations, except structural, to existing *buildings* or *structures* that do not involve additions thereto;
- b) that portion of a *building* or *structure* to be used as a *carport* or garage;
- c) *farm buildings* other than *dwelling units* and closed-sided *livestock* housing;

- d) closed-sided *livestock* housing behind *standard dykes*;
- e) on-loading and off-loading facilities associated with water-oriented industries and portable sawmills.

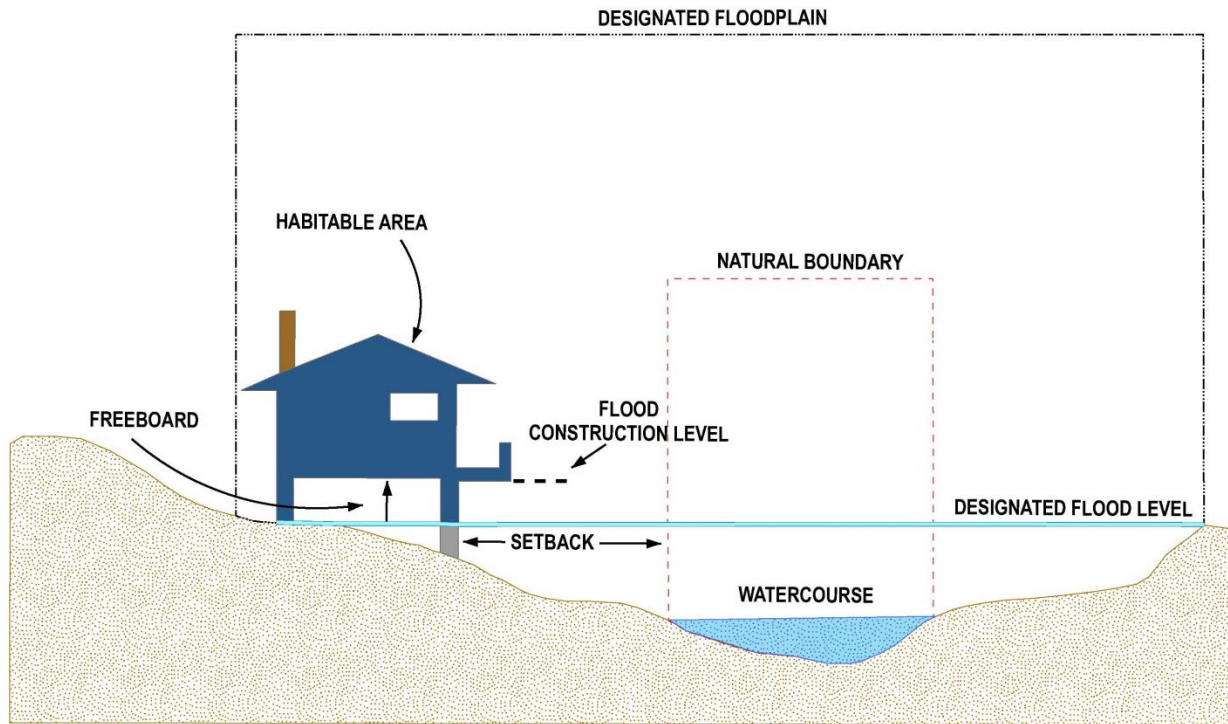

Figure 6 – Floodplain Illustration

11.0 VEHICLE PARKING & LOADING REGULATIONS

11.1 Basic Provisions

- .1 Section 11.0 of this bylaw applies only to *highways* not subject to provincially controlled access regulations.
- .2 Space for the off-street parking and loading of motor vehicles in respect of a class of a *building* or use under this Bylaw must be provided and maintained in accordance with the regulations of this Section.
- .3 In any Residential zone, no vehicle or equipment having a gross vehicle weight in excess of 3,900 kg shall be parked or stored on a *parcel* unless stored such that the vehicle or equipment is entirely enclosed within a *building*, except a *recreational vehicle* belonging to the owner or occupier of the *principal dwelling unit* on a *parcel*.

11.2 Calculation of Off-Street Vehicle Parking Spaces

- .1 The number of off-street parking and loading spaces for motor vehicles required for any use is calculated according to Table 11.2 of this Bylaw.
- .2 In reference to a *building* or use permitted under this Bylaw which is not specifically referred to in Table 11.2, the number of off-street parking and loading spaces is calculated on the basis of the requirements for a similar class of *building* or use that is listed in Table 11.2.
- .3 Where the calculation of the required off-street parking or loading space results in a fraction, the required number of spaces shall be rounded down to the nearest whole number.
- .4 Where more than one *building* or use is located on a *parcel*, the required number of off-street parking spaces shall be the sum of the requirements for each use, unless otherwise expressly provided for in this Bylaw.
- .5 Where more than one standard may apply to a use, the standard requiring the greatest number of parking spaces shall be used.

Table 11.2: Required Off-Street Vehicle Parking Spaces

USE	REQUIRED NUMBER OF SPACES
RESIDENTIAL	
<i>accessory dwelling</i>	1 per <i>dwelling unit</i>
<i>bed and breakfast operation</i>	1 per <i>sleeping unit</i>
<i>duplex dwelling</i>	1 per <i>dwelling unit</i>
<i>manufactured home park</i>	1 per <i>manufactured home</i> ; and 1 per 5 <i>manufactured homes</i> for visitors
<i>apartment building or townhouse</i>	1.75 per <i>dwelling unit</i>
<i>secondary suite</i>	1 per <i>dwelling unit</i>

USE	REQUIRED NUMBER OF SPACES
<i>single detached dwelling</i>	1 per <i>dwelling unit</i>
COMMERCIAL	
<i>alcohol production facility</i>	1 per 30 m ² of <i>gross floor area</i> of customer service area
<i>campground</i>	1 per camping space
<i>eating and drinking establishment</i>	1 per 4 seats; or 1 per 10 m ² of customer service floor area, whichever is greater
<i>golf course</i>	2 per golf hole
<i>indoor recreation</i>	1 per 50.0 m ² of <i>gross floor area</i>
<i>outdoor recreation</i>	25 per playing field
<i>office</i>	1 per 30.0 m ² of <i>gross floor area</i>
<i>personal service establishment</i>	1 per 30.0 m ² of <i>gross floor area</i>
<i>retail</i>	1 per 30.0 m ² of <i>gross floor area</i>
<i>service station</i>	1 per 30.0 m ² of <i>gross floor area</i>
<i>tourist accommodation</i>	1 per <i>sleeping unit</i>
<i>vehicle sales and rentals</i>	1 per 70 m ² of sales floor area; and 1 per service bay
<i>veterinary establishment</i>	1 per 30.0 m ² of <i>gross floor area</i>
other commercial uses	1 per 40.0 m ² of <i>gross floor area</i>
INDUSTRIAL	
<i>manufacturing</i>	1 per 200.0 m ² of <i>gross floor area</i>
<i>outdoor storage and self-storage</i>	5 per business
<i>storage and warehouse</i>	1 per 200.0 m ² of <i>gross floor area</i>
other industrial uses	1 per 200.0 m ² of <i>gross floor area</i>
RURAL	
<i>agri-tourism</i>	4 per business
<i>agri-tourism accommodation</i>	1 per accommodation unit
packing, processing and storage of <i>farm products</i>	1 per 200.0 m ² of <i>gross floor area</i>
<i>retail sales of farm products</i>	1 per 30.0 m ² of <i>gross floor area</i>
MARINE	
<i>boat launch</i>	10 per ramp
<i>marina</i>	1 per 5.0 slips, berths or stalls; and 1 per employee
ADMINISTRATIVE & INSTITUTIONAL	

USE	REQUIRED NUMBER OF SPACES
<i>community care facility</i>	1 per 2 persons licenced occupancy
<i>assembly</i>	1 per 5 seats or 1 per 20 m ² of assembly area, whichever is greater
<i>cultural facility</i>	1 per 40.0 m ² of <i>gross floor area</i>
<i>educational facility</i>	elementary school: 2 per classroom
	middle school: 2 per classroom
	secondary school: 3 per classroom
health care centres and hospitals	1 per 4 beds
other administrative and institutional uses	1 per 30.0 m ² of <i>gross floor area</i>

11.3 Design Standards for Off-Street Vehicle Parking and Loading Areas

- .1 Dimensions for off-street parking and loading spaces shall satisfy the size requirements in Table 11.3 (Dimensions of Parking and Loading Spaces).

Table 11.3: Dimensions of Parking and Loading Spaces

TYPE OF PARKING SPACE	MINIMUM DIMENSIONS		
	Width	Length	Height
Standard Parking Space	2.7 m	6.0 m	2.2 m
Parallel Parking Space	2.7 m	7.0 m	2.2 m
<i>Boat Launch</i> Parking Space	3.0 m	9.0 m	2.2 m
Parking Space for Persons with Disabilities	3.7 m	6.0 m	2.75 m
Loading Space	3.0 m	9.0 m	4.0 m

- .2 Where one or both sides of a parking space abut a wall or other barrier more than 0.15 metres high, an additional 0.3 metres width shall be provided to each abutting parking space on the side(s) adjacent to such a barrier.
- .3 An off-street parking area shall be constructed to permit unobstructed access to and egress from each space at all times, except tandem spaces, as permitted at Section 11.3.6.
- .4 Vehicle access to all parking spaces shall be provided by means of unobstructed manoeuvring aisles, each having widths not less than:
 - i) 7.3 metres, where parking spaces are located at 90 degrees to the manoeuvring aisle providing access to the space;
 - ii) 5.2 metres, where parking spaces are located at 60 degrees to the manoeuvring aisle providing access to the space; or

- iii) 3.7 metres, where the parking spaces are located at 45 degrees or less to the manoeuvring aisle providing access to the space.
- .5 Where parking spaces are located at 60 degrees, or less to the maneuvering aisle, only one-way traffic is permitted in the maneuvering aisle.
- .6 Parking spaces for a *single detached dwelling* and a *home occupation* may be arranged in tandem such that one space is located behind the other space with a common or shared point of access to a *highway*.
- .7 All parking areas containing more than five (5) parking spaces shall be provided with adequate curbs, or wheel stops in order to retain all vehicles within the parking areas and to ensure that *fences, retaining walls*, landscaping and pedestrian paths as well as any *buildings* or *structures* are protected.
- .8 All parking areas with five (5) or more parking spaces in a Medium Density Residential Zone, Administrative and Institutional Zone, Commercial Zone or a Town Centre and Village Zone shall be surfaced with a permanent hard surface of asphalt; concrete; permeable or porous pavement, such as open-jointed pavers, turf or gravel grids or porous concrete or asphalt; interlocking paving stones, or similar hard surface treatment so as to provide a surface that is durable and dust free for the purpose intended.

11.4 Location of Off-Street Parking and Loading Spaces

- .1 Off-street parking and loading spaces shall be located on the same *parcel* as the *building* or use they serve.

12.0 RESOURCE AREA ZONES

12.1 RESOURCE AREA (RA) ZONE

12.1.1 Permitted Uses:

Principal Uses:

- a) *airstrip;*
- b) *agriculture;*
- c) *cemetery;*
- d) *educational facility;*
- e) *equestrian centre;*
- f) *forestry;*
- g) *natural resource extraction;*
- h) *outdoor recreation;*
- i) *scientific research facilities;*
- j) *single detached dwelling or mobile home or recreation vehicle;*
- k) *veterinary establishment;*

Accessory Uses:

- l) *accessory building or structure, subject to Section 7.1;*
- m) *accessory dwelling, subject to Section 7.2;*
- n) *agri-tourism;*
- o) *agri-tourism accommodation, subject to Section 7.3;*
- p) *bed and breakfast operation, subject to Section 7.4;*
- q) *home industry, subject to Section 7.5;*
- r) *home occupation, subject to Section 7.6;*
- s) *kennel, subject to Section 7.7;*
- t) *packing, processing and storage of farm products;*
- u) *retail sales of farm products, subject to Section 7.8; and*
- v) *secondary suite, subject to Section 7.9.*

12.1.2 Minimum Parcel Size for Subdivision:

- a) 60.0 ha, subject to Section 8.0.

12.1.3 Minimum Parcel Width for Subdivision:

- a) Not less than 25% of the *parcel depth*, subject to Section 8.0.

12.1.4 Maximum Number of Dwellings Permitted Per Parcel:

- a) one (1) *principal dwelling unit*;
- b) one (1) *secondary suite*; and
- c) the maximum number of *accessory dwellings* permitted per *parcel* and the total *gross floor area* of all *accessory dwellings* permitted per *parcel* shall not exceed the following:

PARCEL AREA	MAXIMUM NUMBER OF ACCESSORY DWELLINGS	MAXIMUM GROSS FLOOR AREA OF ALL ACCESSORY DWELLINGS PER PARCEL
Less than 8.0 ha	1	125.0 m ²
8.0 ha to 11.9 ha	2	250.0 m ²
12.0 ha to 15.9 ha	3	375.0 m ²
Greater than 16.0 ha	4	500.0 m ²

- d) despite Sections 12.1.4(b) & (c), for *parcels* situated within the Agricultural Land Reserve (ALR), the maximum number of *secondary suites* or *accessory dwellings* permitted per *parcel* under Sections 12.1.4(b) & (c) are permitted only to the extent that a “non-adhering residential use” approval from the Agricultural Land Commission (ALC) has been granted for such *secondary suites* or *accessory dwellings*.

12.1.5 Minimum Setbacks:

- a) *Buildings and structures*:
 - i) *Front parcel line* 7.5 metres
 - ii) *Rear parcel line* 7.5 metres
 - iii) *Interior side parcel line* 7.5 metres
 - iv) *Exterior side parcel line* 7.5 metres
- b) Despite Section 12.1.5(a), *livestock shelters, equestrian centres, generator sheds, boilers or walls with fans, greenhouses and cannabis production, indoor*:
 - i) *Front parcel line* 15.0 metres
 - ii) *Rear parcel line* 15.0 metres
 - iii) *Interior side parcel line* 15.0 metres

- iv) *Exterior side parcel line* 15.0 metres
- c) Despite Section 12.1.5(a), incinerators or *composting operation*:
 - i) *Front parcel line* 30.0 metres
 - ii) *Rear parcel line* 30.0 metres
 - iii) *Interior side parcel line* 30.0 metres
 - iv) *Exterior side parcel line* 30.0 metres
- d) Despite Section 12.1.5(a), *gravel processing*:
 - i) *Front parcel line* 50.0 metres
 - ii) *Rear parcel line* 50.0 metres
 - iii) *Interior side parcel line* 50.0 metres
 - iv) *Exterior side parcel line* 50.0 metres

12.1.6 Maximum Height:

- a) No *building* or *structure* shall exceed a *height* of 10.0 metres.

12.1.7 Maximum Parcel Coverage:

- a) 35% for *parcels* less than 2,500 m² in area;
- b) 20% for *parcels* greater than 2,500 m² and less than 2.0 ha in area; and
- c) for *parcels* greater than 2.0 ha in area:
 - i) 5%; and
 - ii) 75% for a *greenhouse*.

12.1.8 Resource Area Site Specific (RAs) Regulations:

- a) in the case of land described as District Lot 405, SDYD (2141 Willies Ranch Road), and shown hatched on Figure 12.1.8(a):
 - i) The following uses and no other shall be permitted on the land:
 - a) *institutional camp*.

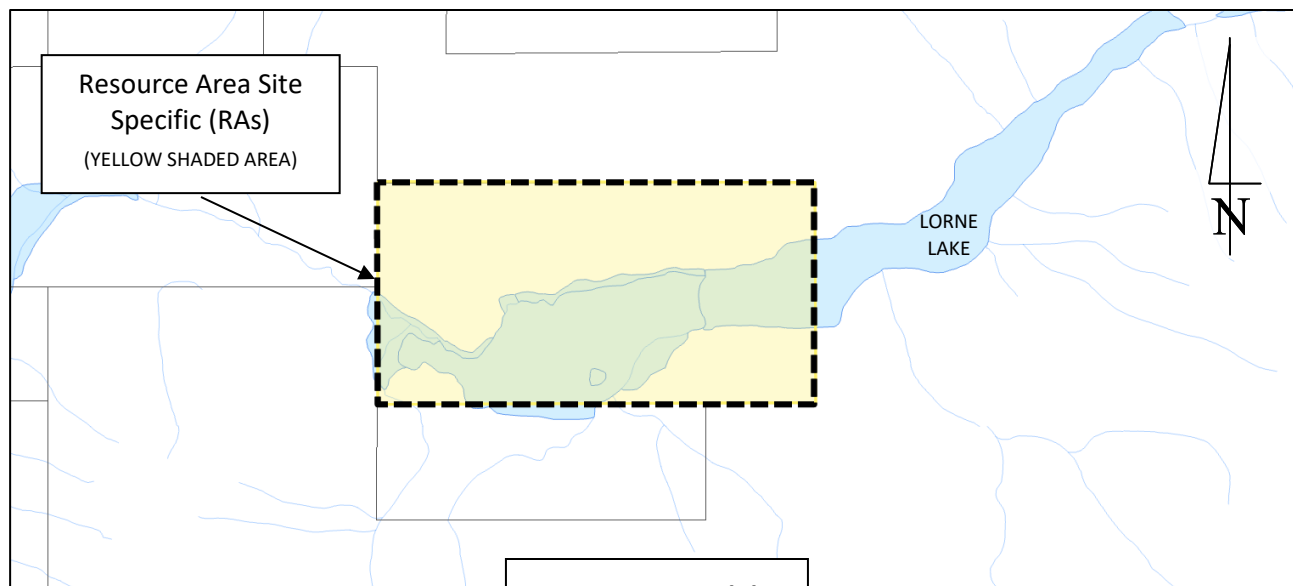

Figure 12.1.8(a)

- b) in the case of an approximately 9.0 ha area of land described as a portion of un-surveyed Crown Land adjacent to District Lot 2582s, SDYD, and shown hatched on Figure 12.1.8(b):
 - i) the following principal use shall be permitted on the land in addition to the permitted uses listed in Section 12.1.1:
 - a) *composting operation.*

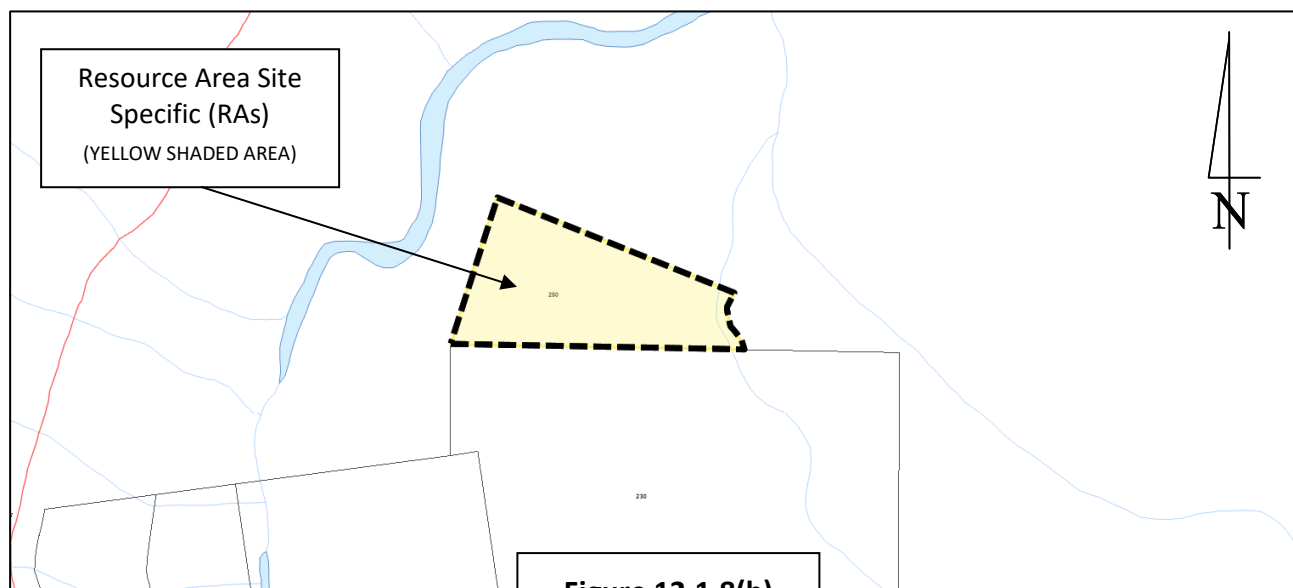
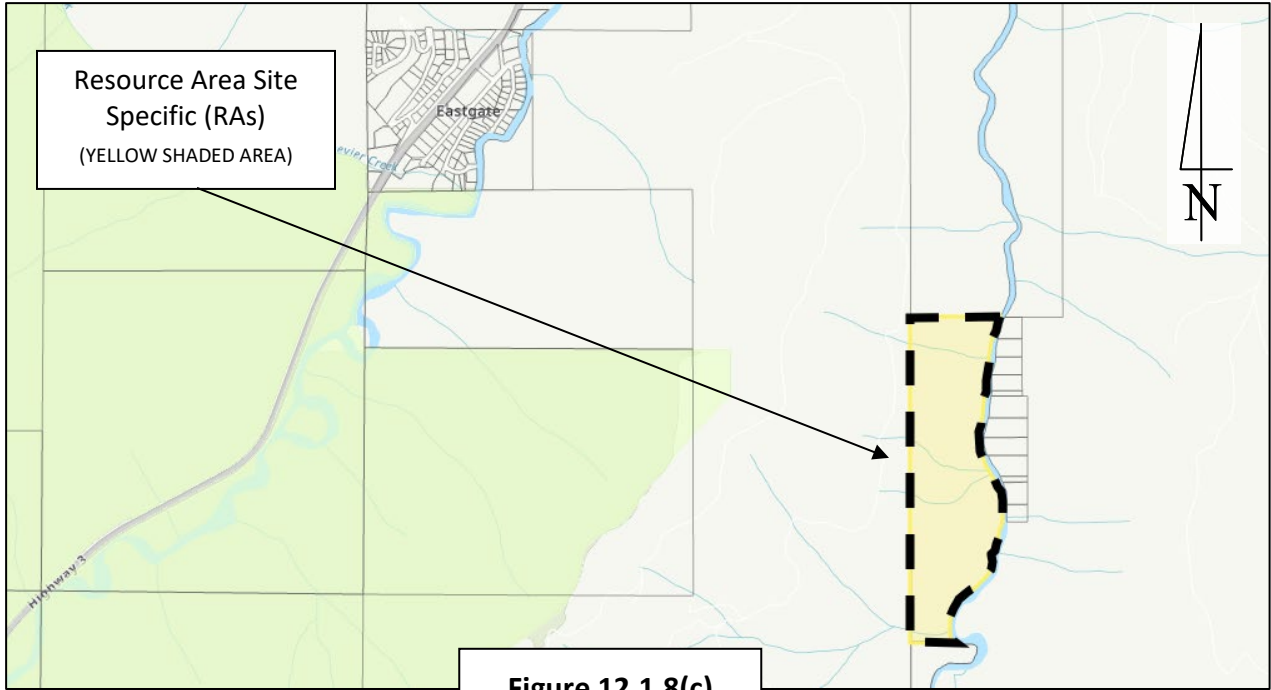

Figure 12.1.8(b)

- c) in the case of the parcel described as District Lot 628, YDYG (602 Pasayten Valley Road), and shown hatched on Figure 12.1.8(c):

- i) despite Section 12.1.4, the maximum number of principal dwellings permitted is one (1) per 3.0 ha to a maximum of 17.



- d) in the case of the parcel described as District Lot 629, YDYD (698 Pasayten Valley Road), and shown shaded on Figure 12.1.8(d):
 - i) despite Section 12.1.4, the maximum number of principal dwellings permitted is one (1) per 3.0 ha to a maximum of 12.

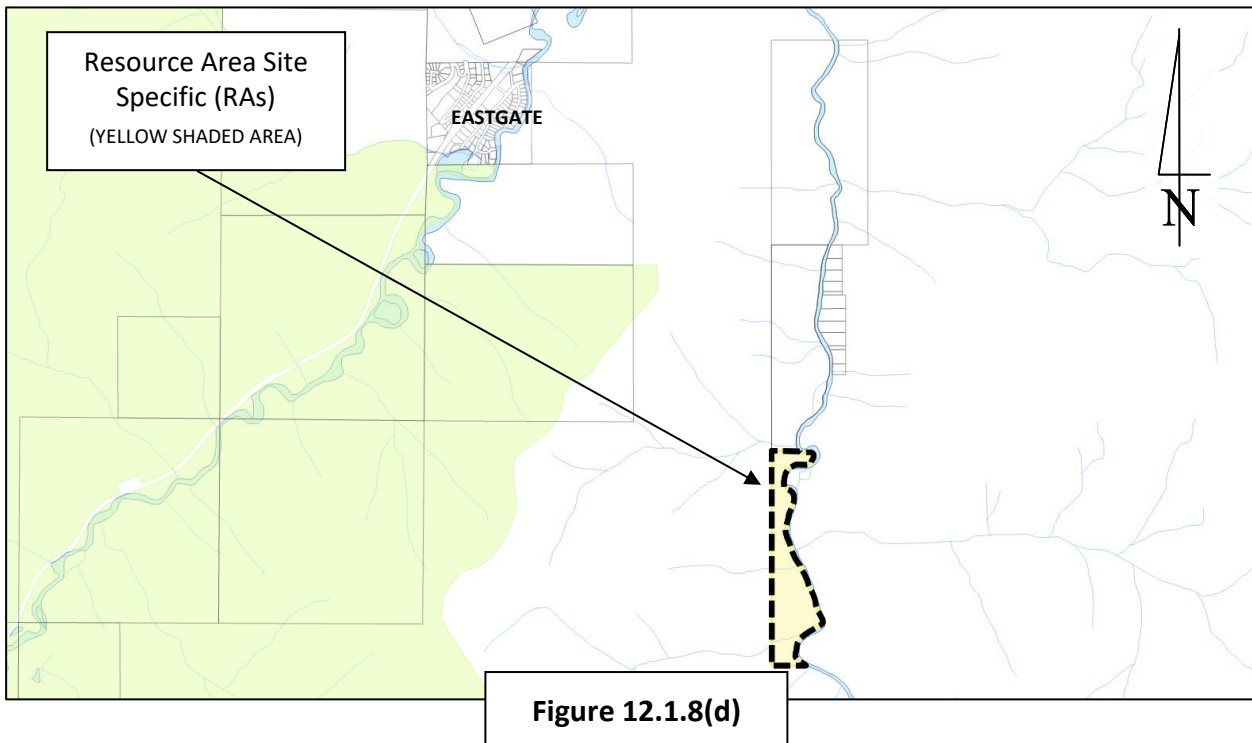

- e) in the case of the parcel described as Lot 2, District Lot 2076 KDYD, Plan KAP78220, and shown shaded yellow on Figure 12.1.8(e):
- i) an *accessory dwelling* may contain cooking, eating, washroom, living and sleeping facilities;
 - ii) despite Section 12.1.4(c), the maximum number of *accessory dwellings* permitted per *parcel* and the total *gross floor area* of all *accessory dwellings* permitted per *parcel* shall not exceed the following:

MAXIMUM NUMBER OF ACCESSORY DWELLINGS	MAXIMUM GROSS FLOOR AREA OF ACCESSORY DWELLINGS
6	75.0 m ²
3	100.0 m ²
2	150.0 m ²

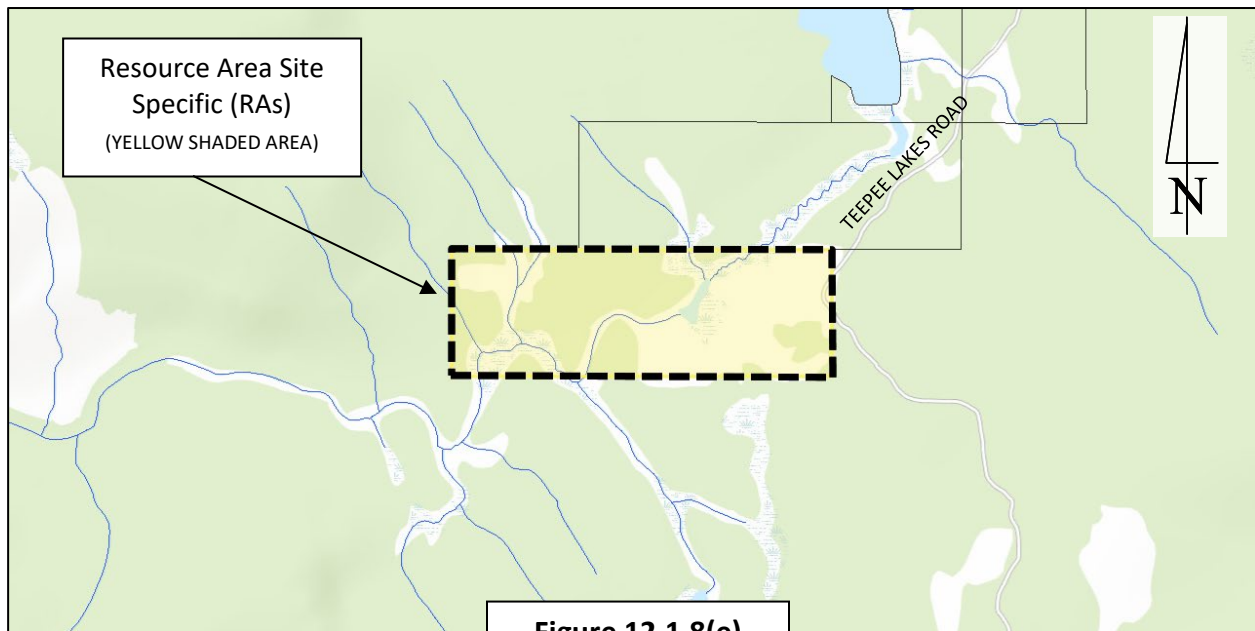

Figure 12.1.8(e)

- f) In the case of an approximately 12.67 ha part of the land described as a portion of un-surveyed Crown Land in the vicinity of District Lot 892, YDYD, and shown shaded yellow on Figure 12.1.8(f):
- i) the following principal use shall be permitted on the land in addition to the permitted uses listed in Section 12.1.1:
 - .1 *composting operation*.

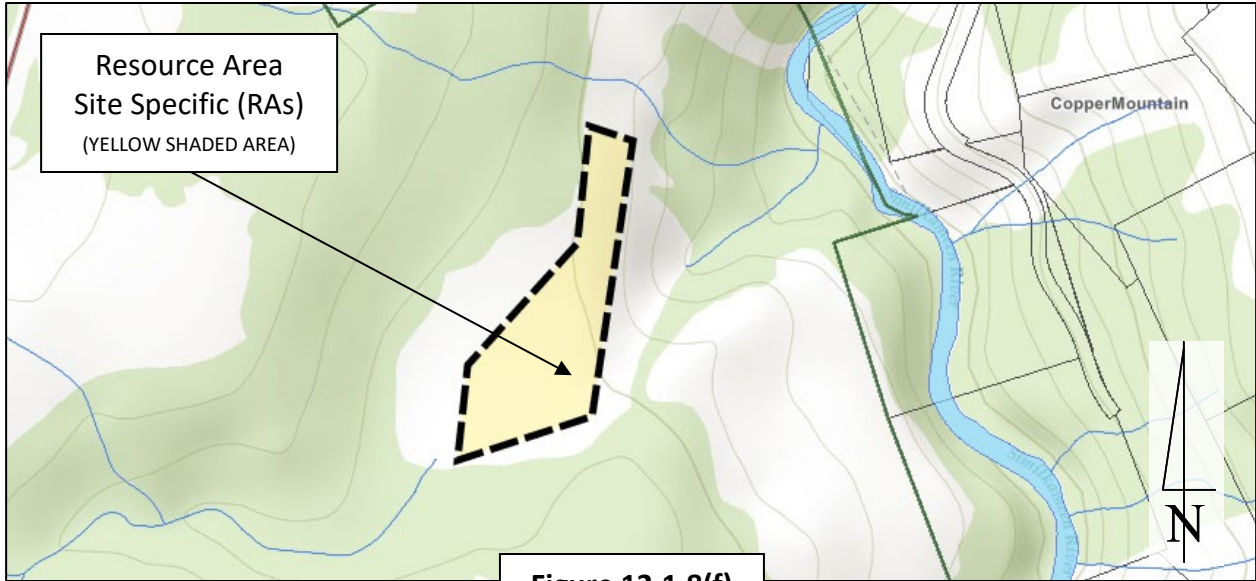

Figure 12.1.8(f)

- g) In the case of land described as District Lot 4539, Portion NE ¼, KDYD (4950 TeePee Lakes Road), and shown shaded yellow on Figure 12.1.8(g):
 - i) the following principal uses shall be permitted on the land in addition to the permitted uses listed in Section 12.1.1:
 - .1 *tourist accommodation*; and
 - ii) the following accessory uses shall be permitted on the land in addition to the permitted uses listed in Section 12.1.1
 - .1 *eating and drinking establishment*; and
 - .2 *retail, not to exceed 250.0 m² in gross floor area.*

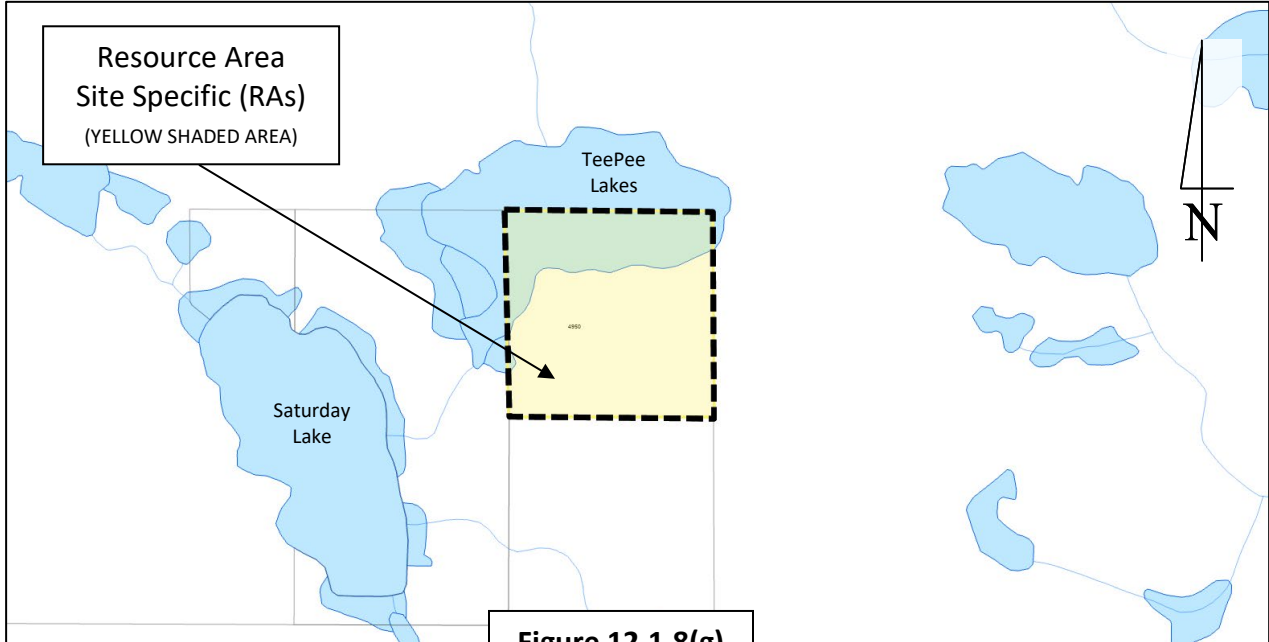

Figure 12.1.8(g)

12.2 WATERSHED RESOURCE AREA (WRA) ZONE

12.2.1 Permitted Uses:

Principal Uses:

- a) *agriculture;*
- b) *conservation area;*

Accessory Uses:

- c) *accessory building or structure, subject to Section 7.1;*

12.2.2 Minimum Parcel Size for Subdivision:

- a) 120.0 ha

12.2.3 Minimum Parcel Width for Subdivision:

- a) Not applicable

12.2.4 Maximum Number of Dwellings Permitted Per Parcel:

- a) Not applicable

12.2.5 Minimum Setbacks:

- a) Not applicable

12.2.6 Maximum Height:

- a) Not applicable

12.2.7 Maximum Parcel Coverage:

- a) Not applicable

12.2.8 Watershed Resource Area Site Specific (RAs) Regulations:

- a) in the case of land shown shaded yellow on Figure 12.2.8(a):
 - i) the following principal use shall be permitted on the land in addition to the permitted uses listed in Section 11.2.1:
 - .1 “seasonal cabin”, which is defined as meaning a building or structure that may contain cooking, eating, washroom, living and sleeping facilities, and is primarily used for occasional or seasonal occupancy.
 - ii) no seasonal cabin shall have a floor area greater than 150.0 m².

- iii) despite Section 11.2.4, the maximum number of dwellings permitted per parcel shall be one (1) seasonal cabin.
- iv) Despite Section 11.2.5, the minimum front setbacks for a building or structure shall be:
 - .1 Buildings and structures:
 - a) Front parcel line 4.5 metres
 - b) Rear parcel line 7.5 metres
 - c) Interior side parcel line 1.5 metres
 - d) Exterior side parcel line 4.5 metres
 - .2 Accessory buildings and structures:
 - a) Front parcel line 4.5 metres
 - b) Rear parcel line 3.0 metres
 - c) Interior side parcel line 1.5 metres
 - d) Exterior side parcel line 4.5 metres
- v) despite Section 11.2.6, the maximum height for a building or structure shall be 9.0 metres.
- vi) despite Section 11.2. 7, the maximum parcel coverage shall be 35%.

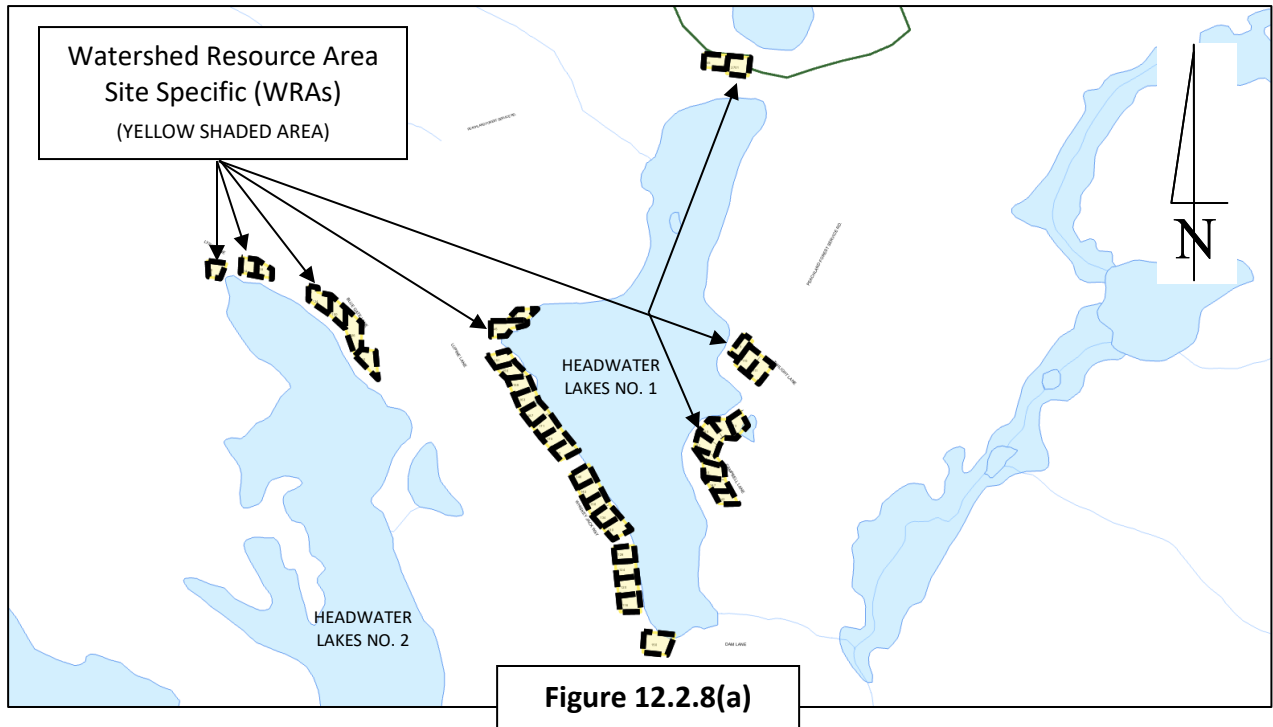

- b) in the case of land described as District Lot 2755, Lease No. 345647, KDYD, and as shown hatched on Figure 11.2.8(b):
- i) the following principal use shall be permitted on the land in addition to the permitted uses listed in Section 11.2.1:
 - .1 fishing camp, including accessory lodge facilities, not exceeding 250.0 m²;
 - .2 tourist cabin, subject to Section 7.25;
 - .3 *single detached dwelling* or “manufactured home”; and
 - .4 *campground*.
 - ii) the maximum number of tourist cabins shall not exceed ten (10).
 - iii) the maximum number of campsites shall not exceed 14.
 - iv) despite Section 11.2.4, the maximum number of dwellings permitted per parcel shall be one (1).
 - v) despite Section 11.2.5, the minimum front setbacks for a building or structure shall be:
 - .1 Buildings and structures:
 - a) Front parcel line 4.5 metres
 - b) Rear parcel line 7.5 metres
 - c) Interior side parcel line 1.5 metres
 - d) Exterior side parcel line 4.5 metres
 - .2 Accessory buildings and structures:
 - a) Front parcel line 4.5 metres
 - b) Rear parcel line 3.0 metres
 - c) Interior side parcel line 1.5 metres
 - d) Exterior side parcel line 4.5 metres
 - vi) despite Section 11.2.6, the maximum height for a building or structure shall be 9.0 metres.
 - vii) despite Section 11.2.7, the maximum parcel coverage shall be 20%.

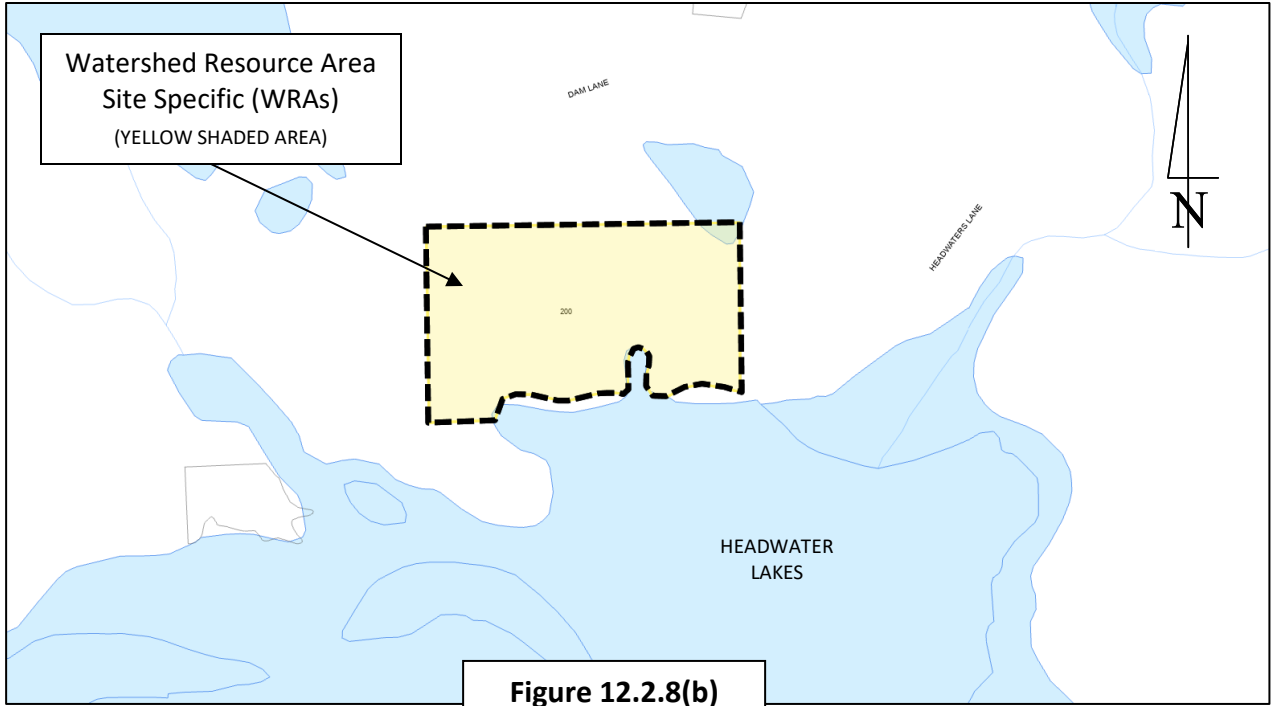

13.0 AGRICULTURE ZONES

13.1 AGRICULTURE THREE (AG3) ZONE

13.1.1 Permitted Uses:

Principal Uses:

- a) *agriculture*;
- b) *alcohol production facility*, subject to Section 7.8;
- c) *equestrian centre*;
- d) *packing, processing, and storage of farm and off-farm products*;
- e) *single detached dwelling or mobile home*;

Accessory Uses:

- f) *accessory building or structure*, subject to Section 7.1;
- g) *accessory dwelling or mobile home*, subject to Section 7.2;
- h) *agri-tourism*;
- i) *agri-tourism accommodation*, subject to Section 7.3;
- j) *bed and breakfast operation*, subject to Section 7.4;
- k) *home industry*, subject to Section 7.5;
- l) *home occupation*, subject to Section 7.6;
- m) *kennel*, subject to Section 7.7;
- n) *retail sales of farm products*, subject to Section 7.8;
- o) *secondary suite*, subject to Section 7.9; and
- p) *veterinary establishment*.

13.1.2 Minimum Parcel Size for Subdivision:

- a) 20.0 ha, subject to Section 8.0

13.1.3 Minimum Parcel Width for Subdivision:

- a) Not less than 25% of the *parcel depth*, subject to Section 8.0.

13.1.4 Maximum Number of Dwellings Permitted Per Parcel:

- a) one (1) *principal dwelling unit*;

- b) one (1) secondary suite; and
- c) the maximum number of *accessory dwellings* permitted per *parcel* and the total *gross floor area* of all *accessory dwellings* permitted per *parcel* shall not exceed the following:

PARCEL AREA	MAXIMUM NUMBER OF ACCESSORY DWELLINGS	MAXIMUM GROSS FLOOR AREA OF ALL ACCESSORY DWELLINGS PER PARCEL
Less than 8.0 ha	1	125.0 m ²
8.0 ha to 11.9 ha	2	250.0 m ²
12.0 ha to 15.9 ha	3	375.0 m ²
Greater than 16.0 ha	4	500.0 m ²

- d) despite Sections 13.1.4(b) & (c), for *parcels* situated within the Agricultural Land Reserve (ALR), the maximum number of *secondary suites* or *accessory dwellings* permitted per *parcel* under Sections 13.1.4(b) & (c) are permitted only to the extent that a “non-adhering residential use” approval from the Agricultural Land Commission (ALC) has been granted for such *secondary suites* or *accessory dwellings*

13.1.5 Minimum Setbacks:

- a) *Buildings and structures on parcels 2,500 m² or greater:*
 - i) *Front parcel line* 7.5 metres
 - ii) *Rear parcel line* 7.5 metres
 - iii) *Interior side parcel line* 4.5 metres
 - iv) *Exterior side parcel line* 7.5 metres
- b) *Buildings or structures on parcels less than 2,500 m²:*
 - i) *Front parcel line* 7.5 metres
 - ii) *Rear parcel line* 7.5 metres
 - iii) *Interior side parcel line* 1.5 metres
 - iv) *Exterior side parcel line* 4.5 metres
- c) *Accessory building or structure on parcels less than 2,500 m²:*
 - i) *Front parcel line* 7.5 metres
 - ii) *Rear parcel line* 1.0 metres
 - iii) *Interior side parcel line* 1.0 metres
 - iv) *Exterior side parcel line* 4.5 metres

- d) Despite Section 13.3.5(a), *livestock shelters, equestrian centres, generator sheds, boilers or walls with fans, greenhouses and cannabis production, indoor:*
 - i) *Front parcel line* 15.0 metres
 - ii) *Rear parcel line* 15.0 metres
 - iii) *Interior side parcel line* 15.0 metres
 - iv) *Exterior side parcel line* 15.0 metres
- e) Despite Section 13.3.5(a), *incinerator or composting operation:*
 - i) *Front parcel line* 30.0 metres
 - ii) *Rear parcel line* 30.0 metres
 - iii) *Interior side parcel line* 30.0 metres
 - iv) *Exterior side parcel line* 30.0 metres

13.1.6 Maximum Height:

- a) *No building, accessory building or structure shall exceed a height of 10.0 metres;*
- b) *despite Section 13.1.6(a), on parcels less than 2,500 m² in area, no accessory building or structure shall exceed a height of 4.5 metres*

13.1.7 Maximum Parcel Coverage:

- a) *35% for parcels less than 2,500 m² in area;*
- b) *20% for parcels between 2,500 m² and 2.0 ha in area;*
- c) *for parcels greater than 2.0 ha in area:*
 - i) *10%; and*
 - ii) *75% for a greenhouse.*

13.1.8 Agriculture Three Site Specific (AG3s) Regulations:

- a) *in the case of land described as District Lot 1009, YDYG, Except Plan B4752 & E8953, Plan KAP68163 (1818 Highway 5A), and shown shaded yellow on Figure 13.1.8(a):*
 - i) *the following principal uses shall be permitted on the land in addition to the permitted uses listed in Section 13.1.1:*
 - .1 *institutional camp.*

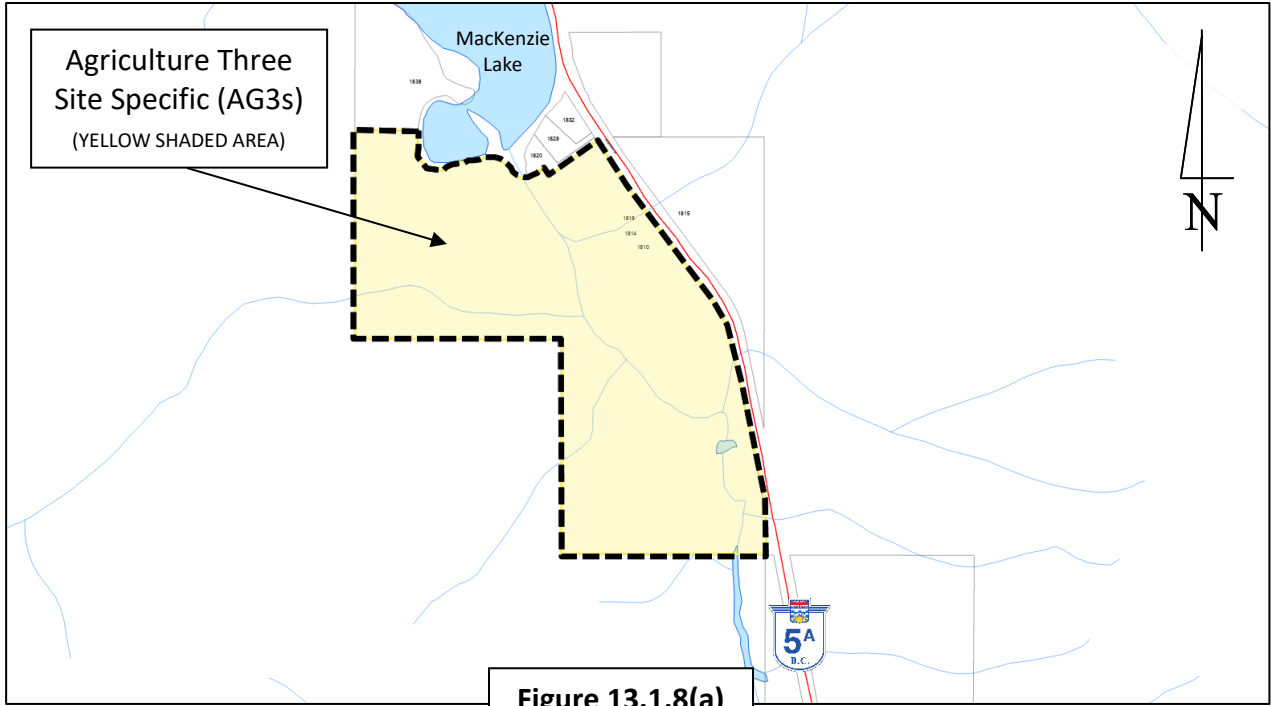

Figure 13.1.8(a)

14.0 LARGE HOLDINGS ZONES

14.1 LARGE HOLDINGS ONE (LH1) ZONE

14.1.1 Permitted Uses:

Principal Uses:

- a) *agriculture;*
- b) *equestrian centre;*
- c) *single detached dwelling or mobile home or recreation vehicle;*
- d) *veterinary establishment;*

Accessory Uses:

- e) *accessory building or structure, subject to Section 7.1;*
- f) *accessory dwelling or mobile home, subject to Section 7.2;*
- g) *bed and breakfast operation, subject to Section 7.4;*
- h) *home industry, subject to Section 7.5;*
- i) *home occupation, subject to Section 7.6;*
- j) *kennel, subject to Section 7.7;*
- k) *secondary suite, subject to Section 7.9.*

14.1.2 Minimum Parcel Size for Subdivision:

- a) 4.0 ha, subject to Section 8.0.

14.1.3 Minimum Parcel Width for Subdivision:

- a) Not less than 25% of the *parcel depth*, subject to Section 8.0.

14.1.4 Maximum Number of Dwellings Permitted Per Parcel:

- a) one (1) *principal dwelling unit;*
- b) one (1) *secondary suite;* and
- c) the maximum number of *accessory dwellings* permitted per *parcel* and the total *gross floor area* of all *accessory dwellings* permitted per *parcel* shall not exceed the following:

<i>PARCEL AREA</i>	<i>MAXIMUM NUMBER OF ACCESSORY DWELLINGS</i>	<i>MAXIMUM GROSS FLOOR AREA OF ALL ACCESSORY DWELLINGS PER PARCEL</i>
Less than 8.0 ha	1	125.0 m ²
8.0 ha to 11.9 ha	2	250.0 m ²
12.0 ha to 15.9 ha	3	375.0 m ²
Greater than 16.0 ha	4	500.0 m ²

- d) despite Sections 14.1.4(b) & (c), for *parcels* situated within the Agricultural Land Reserve (ALR), the maximum number of *secondary suites* or *accessory dwellings* permitted per *parcel* under Sections 14.1.4(b) & (c) are permitted only to the extent that a “non-adhering residential use” approval from the Agricultural Land Commission (ALC) has been granted for such *secondary suites* or *accessory dwellings*.

14.1.5 Minimum Setbacks:

- a) *Buildings and structures on parcels 2,500 m² or greater:*
- i) *Front parcel line* 7.5 metres
 - ii) *Rear parcel line* 7.5 metres
 - iii) *Interior side parcel line* 4.5 metres
 - iv) *Exterior side parcel line* 7.5 metres
- b) *Buildings or structures on parcels less than 2,500 m²:*
- i) *Front parcel line* 7.5 metres
 - ii) *Rear parcel line* 7.5 metres
 - iii) *Interior side parcel line* 1.5 metres
 - iv) *Exterior side parcel line* 4.5 metres
- c) *Accessory building or structure on parcels less than 2,500 m²:*
- i) *Front parcel line* 7.5 metres
 - ii) *Rear parcel line* 1.0 metres
 - iii) *Interior side parcel line* 1.0 metres
 - iv) *Exterior side parcel line* 4.5 metres
- d) Despite Section 14.1.5(a), *livestock shelters, equestrian centres, generator sheds, boilers or walls with fans, greenhouses and cannabis production, indoor:*
- i) *Front parcel line* 15.0 metres
 - ii) *Rear parcel line* 15.0 metres

- iii) *Interior side parcel line* 15.0 metres
- iv) *Exterior side parcel line* 15.0 metres
- e) Despite Section 14.1.5(a), incinerator or *composting operation*:
 - i) *Front parcel line* 30.0 metres
 - ii) *Rear parcel line* 30.0 metres
 - iii) *Interior side parcel line* 30.0 metres
 - iv) *Exterior side parcel line* 30.0 metres

14.1.6 Maximum Height:

- a) No *building, accessory building or structure* shall exceed a *height* of 10.0 metres;
- b) despite Section 14.1.6(a), on *parcels* less than 2,500 m² in area, no *accessory building or structure* shall exceed a *height* of 4.5 metres.

14.1.7 Maximum Parcel Coverage:

- a) 35% for *parcels* less than 2,500 m² in area;
- b) 20% for *parcels* between 2,500 m² and 2.0 ha in area;
- c) for *parcels* greater than 2.0 ha in area:
 - i) 10%; and
 - ii) 75% for a *greenhouse*.

14.1.8 Large Holdings One Site Specific (LH1s) Regulations:

- a) Not applicable

14.2 LARGE HOLDINGS TWO (LH2) ZONE

14.2.1 Permitted Uses:

Principal Uses:

- a) *agriculture;*
- b) *equestrian centre;*
- c) *forestry;*
- d) *outdoor recreation;*
- e) *single detached dwelling or mobile home or recreational vehicle;*
- f) *veterinary establishment;*

Accessory Uses:

- g) *accessory building or structure, subject to Section 7.1;*
- h) *accessory dwelling or mobile home, subject to Section 7.2;*
- i) *bed and breakfast operation, subject to Section 7.4;*
- j) *home industry, subject to Section 7.5;*
- k) *home occupation, subject to Section 7.6;*
- l) *kennel, subject to Section 7.7;*
- m) *packing, processing and storage of farm products;*
- n) *retail sales of farm products, subject to Section 7.8; and*
- o) *secondary suite, subject to Section 7.9.*

14.2.2 Minimum Parcel Size for Subdivision:

- a) 8.0 ha, subject to Section 8.0.

14.2.3 Minimum Parcel Width for Subdivision:

- a) Not less than 25% of the *parcel depth*, subject to Section 8.0.

14.2.4 Maximum Number of Dwellings Permitted Per Parcel:

- a) one (1) *principal dwelling unit;*
- b) one (1) *secondary suite;* and
- c) the maximum number of *accessory dwellings* permitted per *parcel* and the total *gross floor area* of all *accessory dwellings* permitted per *parcel* shall not exceed the following:

PARCEL AREA	MAXIMUM NUMBER OF ACCESSORY DWELLINGS	MAXIMUM GROSS FLOOR AREA OF ALL ACCESSORY DWELLINGS PER PARCEL
Less than 8.0 ha	1	125.0 m ²
8.0 ha to 11.9 ha	2	250.0 m ²
12.0 ha to 15.9 ha	3	375.0 m ²
Greater than 16.0 ha	4	500.0 m ²

- d) despite Sections 14.2.4(b) & (c), for *parcels* situated within the Agricultural Land Reserve (ALR), the maximum number of *secondary suites* or *accessory dwellings* permitted per *parcel* under Sections 14.2.4(b) & (c) are permitted only to the extent that a “non-adhering residential use” approval from the Agricultural Land Commission (ALC) has been granted for such *secondary suites* or *accessory dwellings*.

14.2.5 Minimum Setbacks:

- a) *Buildings and structures on parcels 2,500 m² or greater:*
- i) *Front parcel line* 7.5 metres
 - ii) *Rear parcel line* 7.5 metres
 - iii) *Interior side parcel line* 4.5 metres
 - iv) *Exterior side parcel line* 7.5 metres
- b) Despite Section 14.2.5(a), *livestock shelters, equestrian centres, generator sheds, boilers or walls with fans, greenhouses and cannabis production, indoor:*
- i) *Front parcel line* 15.0 metres
 - ii) *Rear parcel line* 15.0 metres
 - iii) *Interior side parcel line* 15.0 metres
 - iv) *Exterior side parcel line* 15.0 metres
- c) Despite Section 14.2.5(a), *incinerator or composting operation:*
- i) *Front parcel line* 30.0 metres
 - ii) *Rear parcel line* 30.0 metres
 - iii) *Interior side parcel line* 30.0 metres
 - iv) *Exterior side parcel line* 30.0 metres

14.2.6 Maximum Height:

- a) No *building or structure* shall exceed a *height* of 10.0 metres;

- b) despite Section 14.2.6(a), on *parcels* less than 2,500 m² in area, no *accessory building or structure* shall exceed a *height* of 4.5 metres.

14.2.7 Maximum Parcel Coverage:

- a) 35% for *parcels* less than 2,500 m² in area;
- b) 20% for *parcels* between 2,500 m² and 2.0 ha in area;
- c) for *parcels* greater than 2.0 ha in area:
 - i) 10%; and
 - ii) 75% for a *greenhouse*.

14.2.8 Large Holdings Two Site Specific (LH2s) Regulations:

- a) In the case of part of the land described as Lot 2, District Lot 404, Plan KAP64782, SDYD (743 Highway 3), and shown shaded on Figure 14.2.8(a):
 - i) the following principal use shall be permitted on the land in addition to the permitted uses listed in Section 14.2.1:
 - .1 “service industry establishment”.

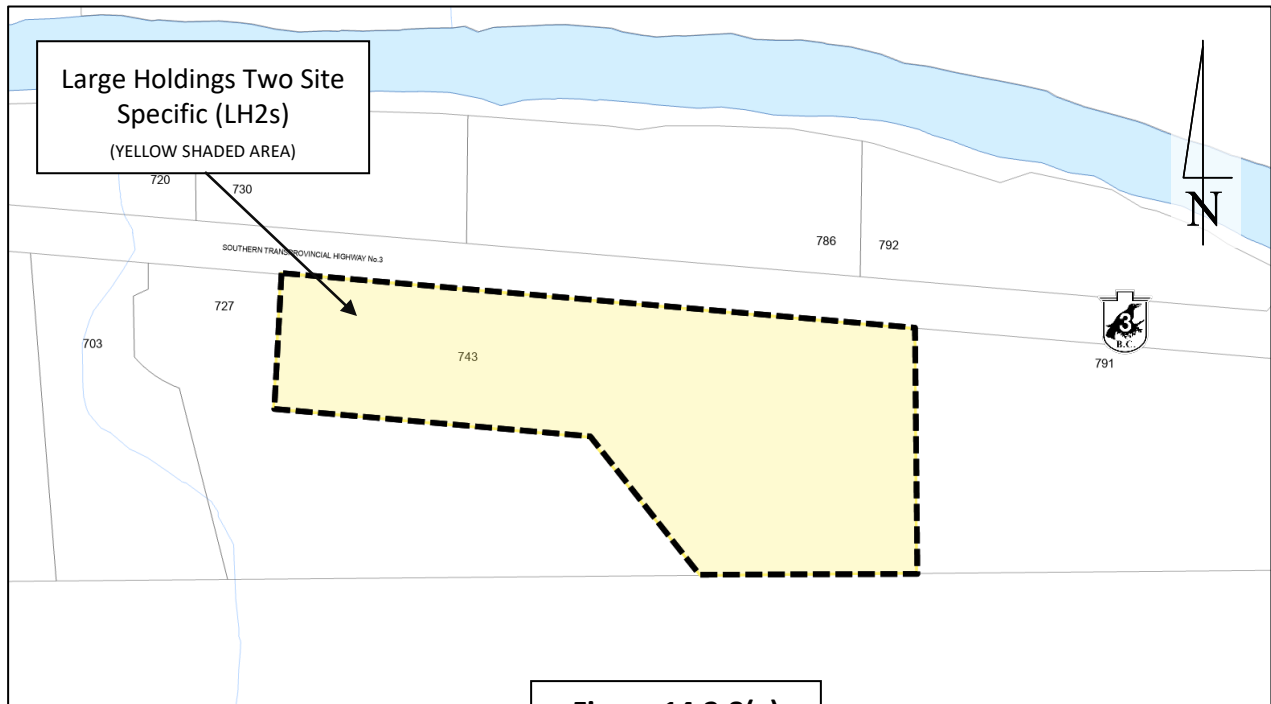
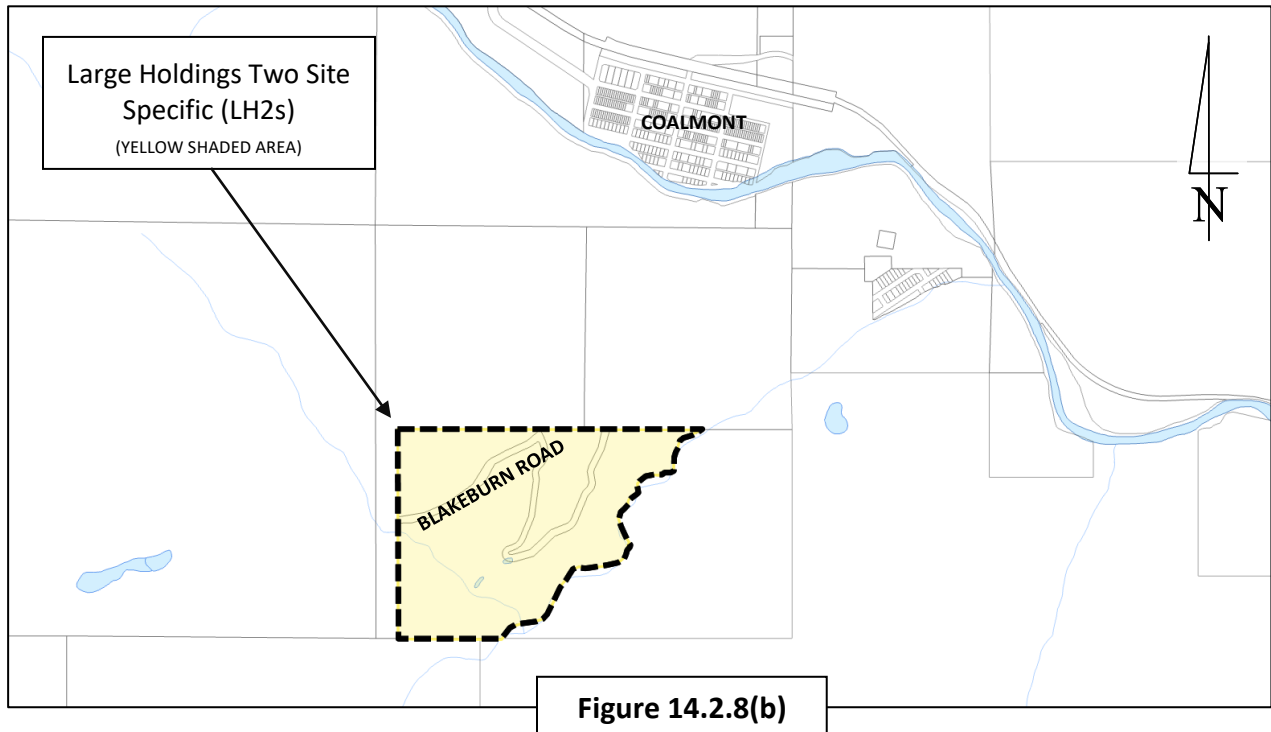

Figure 14.2.8(a)

- b) In the case of the land described as District Lot 520, YDYD, Except Plan KAP80251 (1580 Blakeburn Road), and shown shaded yellow on Figure 14.2.8(b):
 - i) despite Section 14.2.4, the following will apply:

- .1 the maximum number of principal dwellings permitted per parcel is seven (7);
- .2 the maximum number of secondary suites or carriage house permitted per parcel is one (1).

ii) despite Section 14.2.2, the minimum parcel size shall be 60.0 ha.



- c) In the case of the land described as a portion of Northeast ¼ District Lot 376, YDYP (1500 Blakeburn Road), and shown shaded on Figure 14.2.8(c):
- i) despite Section 14.2.2, the minimum parcel size shall be 60.0 ha.
 - ii) despite Section 14.2.4, the maximum number of principal dwellings permitted per parcel is eight (8) and the maximum number of accessory dwellings per parcel is one (1).

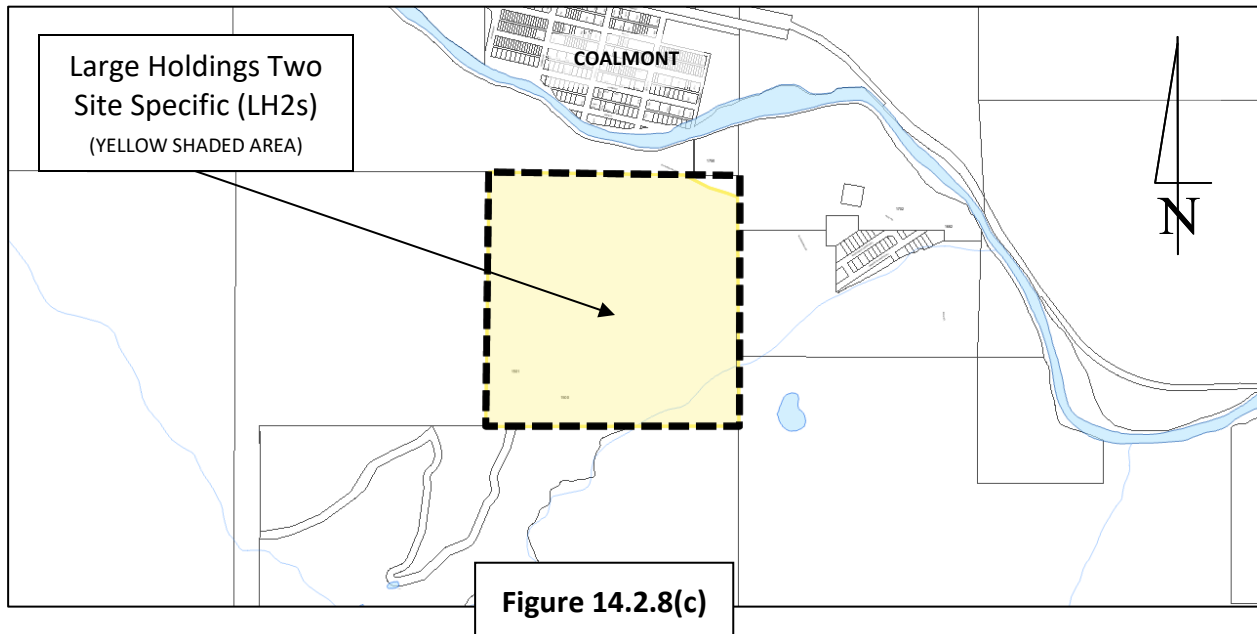

d) In the case of land described as a portion of District Lot 1195, YDYD, Except Those Portions Thereof Included Within the Boundaries of District Lots 901 and 627, and shown shaded yellow on Figure 14.2.8(d):

- i) despite Section 10.5.1, the minimum size for one portion of a hooked parcel shall be 0.2 hectares.

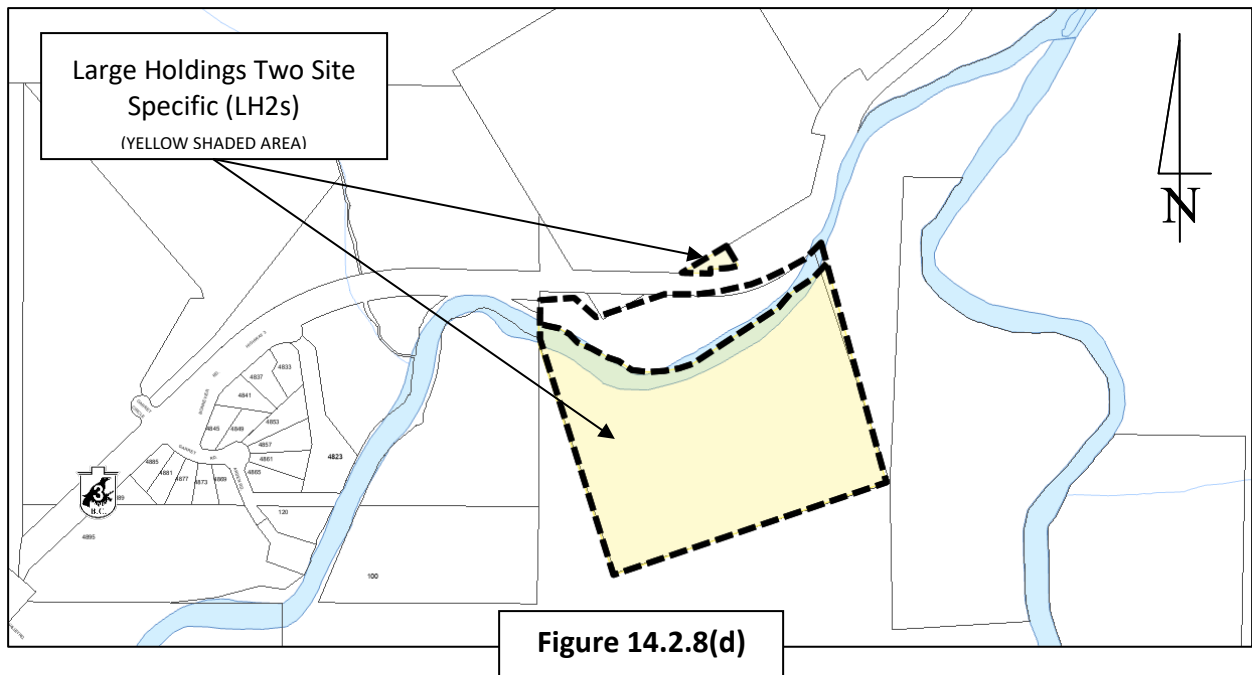

15.0 SMALL HOLDINGS ZONES

15.1 SMALL HOLDINGS ONE (SH1) ZONE

15.1.1 Permitted Uses:

Principal Uses:

- a) *single detached dwelling;*

Accessory Uses:

- b) *accessory building or structure*, subject to Section 7.1;
- c) *accessory dwelling*, subject to Section 7.2;
- d) *bed and breakfast operation*, subject to Section 7.4;
- e) *home occupation*, subject to Section 7.6; and
- f) *secondary suite*, subject to Section 7.9.

15.1.2 Minimum Parcel Size for Subdivision:

- a) 0.25 ha, subject to Section 8.0.

15.1.3 Minimum Parcel Width for Subdivision:

- a) Not less than 25% of the *parcel depth*, subject to Section 8.0.

15.1.4 Maximum Number of Dwellings Permitted Per Parcel:

- a) one (1) *principal dwelling unit*; and
- b) one (1) *secondary suite* or one (1) *accessory dwelling*.

15.1.5 Minimum Setbacks:

a) *Buildings and structures:*

- i) *Front parcel line* 7.5 metres
- ii) *Rear parcel line* 4.5 metres
- iii) *Interior side parcel line* 1.5 metres
- iv) *Exterior side parcel line* 4.5 metres

b) *Accessory building or structure:*

- i) *Front parcel line* 7.5 metres
- ii) *Rear parcel line* 1.5 metres
- iii) *Interior side parcel line* 1.5 metres

iv) *Exterior side parcel line* 4.5 metres

15.1.6 Maximum Height:

- a) No *building or structure* shall exceed a *height* of 10.0 metres;
- b) No *accessory building or structure* shall exceed a *height* of 4.5 metres.

15.1.7 Maximum Parcel Coverage:

- a) 35%

15.1.8 Small Holdings One Site Specific (SH1s) Regulations:

- a) Not applicable

15.2 SMALL HOLDINGS TWO (SH2) ZONE

15.2.1 Permitted Uses:

Principal Uses:

- a) *single detached dwelling or mobile home or recreational vehicle;*

Accessory Uses:

- b) *accessory building or structure, subject to Section 7.1;*
c) *accessory dwelling, subject to Section 7.2;*
d) *agriculture;*
e) *bed and breakfast operation, subject to Section 7.4;*
f) *home occupation, subject to Section 7.6; and*
g) *secondary suite, subject to Section 7.9.*

15.2.2 Minimum Parcel Size for Subdivision:

- a) 0.5 ha, subject to Section 8.0.

15.2.3 Minimum Parcel Width for Subdivision:

- a) Not less than 25% of the *parcel depth*, subject to Section 8.0.

15.2.4 Maximum Number of Dwellings Permitted Per Parcel:

- a) one (1) *principal dwelling unit*; and
b) one (1) *secondary suite* or one (1) *accessory dwelling*.

15.2.5 Minimum Setbacks:

- a) *Buildings and structures:*

- | | |
|---------------------------------------|------------|
| i) <i>Front parcel line</i> | 7.5 metres |
| ii) <i>Rear parcel line</i> | 4.5 metres |
| iii) <i>Interior side parcel line</i> | 4.5 metres |
| iv) <i>Exterior side parcel line</i> | 4.5 metres |

- b) *Accessory building or structure:*

- | | |
|---------------------------------------|------------|
| i) <i>Front parcel line</i> | 7.5 metres |
| ii) <i>Rear parcel line</i> | 4.5 metres |
| iii) <i>Interior side parcel line</i> | 4.5 metres |
| iv) <i>Exterior side parcel line</i> | 4.5 metres |

- c) Despite Section 15.2.5(a) and (b), *livestock shelters, generator sheds, boilers or walls with fans, greenhouses and cannabis production, indoor:*
 - i) *Front parcel line* 15.0 metres
 - ii) *Rear parcel line* 15.0 metres
 - iii) *Interior side parcel line* 15.0 metres
 - iv) *Exterior side parcel line* 15.0 metres
- d) Despite Section 15.2.5(a) and (b), *incinerator or composting operation:*
 - i) *Front parcel line* 30.0 metres
 - ii) *Rear parcel line* 30.0 metres
 - iii) *Interior side parcel line* 30.0 metres
 - iv) *Exterior side parcel line* 30.0 metres

15.2.6 Maximum Height:

- a) No *building or structure* shall exceed a *height* of 11.0 metres.

15.2.7 Maximum Parcel Coverage:

- a) 25%

15.2.8 Small Holdings Two Site Specific (SH2s) Regulations:

- a) Not applicable

15.3 SMALL HOLDINGS THREE (SH3) ZONE

15.3.1 Permitted Uses:

Principal Uses:

- a) *single detached dwelling or mobile home or recreational vehicle;*

Accessory Uses:

- b) *accessory building or structure, subject to Section 7.1;*
c) *accessory dwelling, subject to Section 7.2;*
d) *agriculture;*
e) *bed and breakfast operation, subject to Section 7.4;*
f) *home occupation, subject to Section 7.6; and*
g) *secondary suite, subject to Section 7.9.*

15.3.2 Minimum Parcel Size for Subdivision:

- a) 1.0 ha, subject to Section 8.0.

15.3.3 Minimum Parcel Width for Subdivision:

- a) Not less than 25% of the *parcel depth*, subject to Section 8.0.

15.3.4 Maximum Number of Dwellings Permitted Per Parcel:

- a) one (1) *principal dwelling unit;*
b) one (1) *secondary suite; and*
c) one (1) *accessory dwelling.*

15.3.5 Minimum Setbacks:

- a) *Buildings and structures:*

- | | |
|---------------------------------------|------------|
| i) <i>Front parcel line</i> | 7.5 metres |
| ii) <i>Rear parcel line</i> | 4.5 metres |
| iii) <i>Interior side parcel line</i> | 4.5 metres |
| iv) <i>Exterior side parcel line</i> | 4.5 metres |

- b) *Accessory building or structure:*

- | | |
|---------------------------------------|------------|
| i) <i>Front parcel line</i> | 7.5 metres |
| ii) <i>Rear parcel line</i> | 4.5 metres |
| iii) <i>Interior side parcel line</i> | 4.5 metres |

- iv) *Exterior side parcel line* 4.5 metres
- c) Despite Section 15.3.5(a) and (b), *livestock shelters, generator sheds, boilers or walls with fans, greenhouses and cannabis production, indoor:*
 - i) *Front parcel line* 15.0 metres
 - ii) *Rear parcel line* 15.0 metres
 - iii) *Interior side parcel line* 15.0 metres
 - iv) *Exterior side parcel line* 15.0 metres
- d) Despite Section 15.3.5(a) and (b), *incinerator or composting operation:*
 - i) *Front parcel line* 30.0 metres
 - ii) *Rear parcel line* 30.0 metres
 - iii) *Interior side parcel line* 30.0 metres
 - iv) *Exterior side parcel line* 30.0 metres

15.3.6 Maximum Height:

- a) No *building, accessory building or structure* shall exceed a *height* of 10.0 metres.

15.3.7 Maximum Parcel Coverage:

- a) 20%

15.3.8 Small Holdings Three Site Specific (SH3s) Regulations:

- a) Not applicable

15.4 SMALL HOLDINGS FOUR (SH4) ZONE

15.4.1 Permitted Uses:

Permitted Uses:

a) *single detached dwelling or mobile home or recreational vehicle;*

Accessory Uses:

b) *accessory building or structure*, subject to Section 7.1;

c) *accessory dwelling*, subject to Section 7.2;

d) *agriculture*;

e) *bed and breakfast operation*, subject to Section 7.4;

f) *home industry*, subject to Section 7.5;

g) *home occupation*, subject to Section 7.6; and

h) *secondary suite*, subject to Section 7.9.

15.4.2 Minimum Parcel Size for Subdivision:

a) 2.0 ha, subject to Section 8.0.

15.4.3 Minimum Parcel Width for Subdivision:

a) Not less than 25% of the *parcel depth*, subject to Section 8.0.

15.4.4 Maximum Number of Dwellings Permitted Per Parcel:

a) one (1) *principal dwelling unit*;

b) one (1) *secondary suite*; and

c) one (1) *accessory dwelling*.

15.4.5 Minimum Setbacks:

a) *Buildings and structures:*

i) *Front parcel line* 7.5 metres

ii) *Rear parcel line* 4.5 metres

iii) *Interior side parcel line* 4.5 metres

iv) *Exterior side parcel line* 4.5 metres

b) *Accessory building or structure:*

i) *Front parcel line* 7.5 metres

ii) *Rear parcel line* 4.5 metres

- iii) *Interior side parcel line* 4.5 metres
- iv) *Exterior side parcel line* 4.5 metres
- c) Despite Section 15.4.5(a) and (b), *livestock shelters, generator sheds, boilers or walls with fans, greenhouses and cannabis production, indoor:*
 - i) *Front parcel line* 15.0 metres
 - ii) *Rear parcel line* 15.0 metres
 - iii) *Interior side parcel line* 15.0 metres
 - iv) *Exterior side parcel line* 15.0 metres
- d) Despite Section 15.4.5(a) and (b), *incinerator or composting operation:*
 - i) *Front parcel line* 30.0 metres
 - ii) *Rear parcel line* 30.0 metres
 - iii) *Interior side parcel line* 30.0 metres
 - iv) *Exterior side parcel line* 30.0 metres

15.4.6 Maximum Height:

- a) No *building, accessory building or structure* shall exceed a *height* of 10.0 metres.

15.4.7 Maximum Parcel Coverage:

- a) 15%

15.4.8 Small Holdings Four Site Specific (SH4s) Regulations:

- a) in the case of land described as Lot 2, District Lot 2076 KDYD, Plan KAP78220 (3492 Princeton-Summerland Road), and shown shaded yellow on Figure 15.4.8(a):
 - i) the following principal use and no others shall be permitted on the land:
 - .1 recreation vehicle(s).
 - ii) the following accessory use and no others shall be permitted on the land:
 - .1 accessory buildings and structures, subject to 7.1.
 - iii) despite Section 15.4.4, the maximum number of recreational vehicles permitted on the subject parcel shall not exceed five (5).

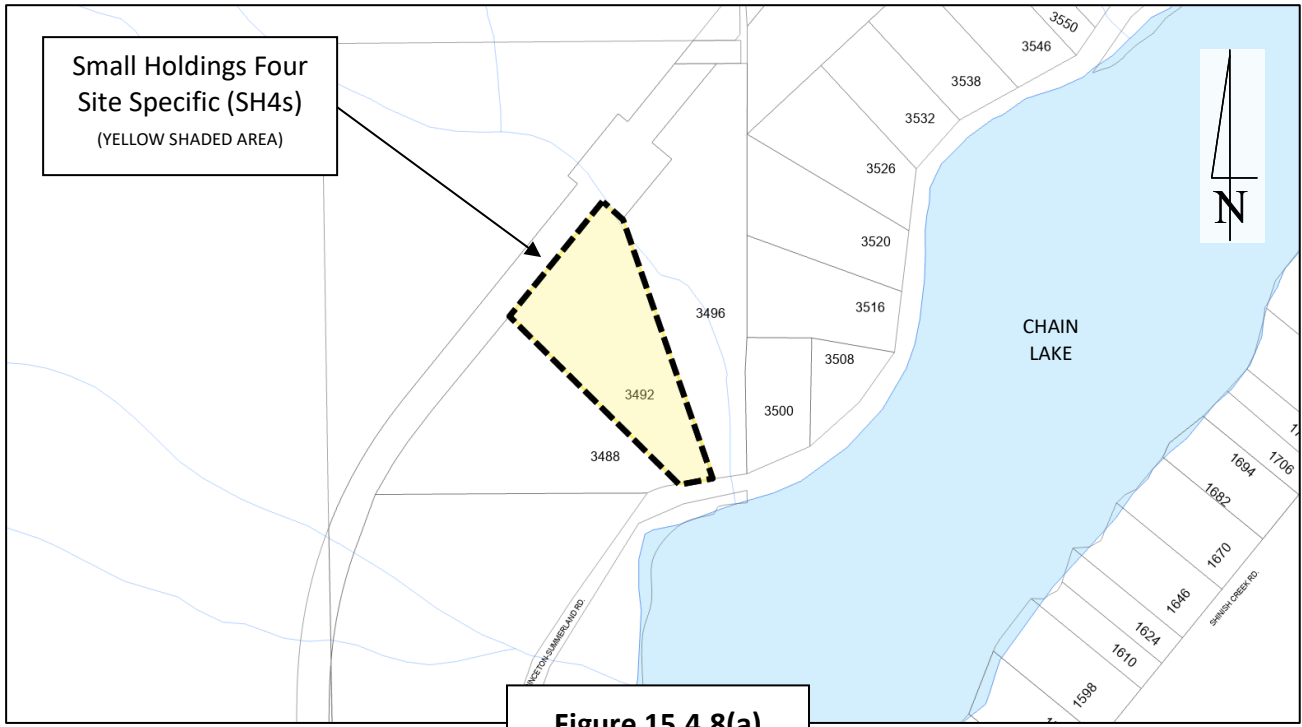

Figure 15.4.8(a)

16.0 LOW DENSITY RESIDENTIAL ZONES

16.1 LOW DENSITY RESIDENTIAL ONE (RS1) ZONE

16.1.1 Permitted Uses:

Principal Uses:

- a) *duplex dwelling*;
- b) *single detached dwelling*;
- c) *mobile home*;

Accessory Uses:

- d) *accessory building or structure*, subject to Section 7.1;
- e) *accessory dwelling*, subject to Section 7.2;
- f) *bed and breakfast operation*, subject to Section 7.4;
- g) *home occupation*, subject to Section 7.6; and
- h) *secondary suite*, subject to Section 7.9.

16.1.2 Minimum Parcel Size for Subdivision:

- a) 225.0 m² for the purpose of subdivision of *duplex dwellings* under the *Strata Property Act*, subject to Section 8.0; or
- b) 500.0 m², subject to Section 8.0.

16.1.3 Minimum Parcel Width for Subdivision:

- a) Not less than 25% of the *parcel depth*, subject to Section 8.0.

16.1.4 Maximum Number of Dwellings Permitted Per Parcel:

- a) one (1) *principal dwelling unit*; and
- b) one (1) *secondary suite* or one (1) *accessory dwelling*.

16.1.5 Minimum Setbacks:

- a) *Buildings and structures:*
 - i) *Front parcel line* 6.0 metres
 - ii) *Rear parcel line* 6.0 metres
 - iii) *Interior side parcel line* 1.2 metres
 - iv) *Exterior side parcel line* 3.0 metres

- b) *Accessory building or structure:*
 - i) *Front parcel line* 6.0 metres
 - ii) *Rear parcel line* 1.0 metres
 - iii) *Interior side parcel line* 1.2 metres
 - iv) *Exterior side parcel line* 3.0 metres
- c) Despite Section 16.1.5(a)(iii), in the case of a side-by-side duplex being subdivided for the purposes of creating individual ownership, an interior side parcel line setback between dwelling units shall not be required, provided the property line follows the centre line of the common property wall.

16.1.6 Maximum Height:

- a) No *building or structure* shall exceed a *height* of 11.0 metres;
- b) No *accessory building or structure* shall exceed a *height* of 4.5 metres;
- c) Despite sub-section 16.1.6(b), an *accessory dwelling* shall not exceed a height of 8.0 metres.

16.1.7 Maximum Parcel Coverage:

- a) 50% for parcels less than 500 m² in area;
- b) 40% for parcels between 500 m² and 1,000 m² in area; and
- c) 35% for parcels greater than 1,000 m² in area.

16.1.8 Conditions of Use:

- a) a *duplex dwelling*, with or without *secondary suites*, shall be connected to a *community sewer system* and *community water system*.

16.1.9 Low Density Residential One Site Specific (RS1s) Regulations:

- a) Not applicable

16.2 LOW DENSITY RESIDENTIAL MANUFACTURED HOME PARK (RSM1) ZONE

16.2.1 Permitted Uses:

Principal Uses:

- a) *manufactured home park*;
- b) *manufactured home*;
- c) *modular home*;

Accessory Uses:

- d) *accessory building or structure*, subject to Section 7.1;
- e) *home occupation*, subject to Section 7.6;
- f) *retail*, subject to Section 16.8.10; and
- g) *single detached dwelling*.

16.2.2 Minimum Parcel Size for Subdivision:

- a) 1.0 ha for *manufactured home park*, subject to Section 8.0; and
- b) 350.0 m² for each *manufactured home space*, subject to Section 8.0.

16.2.3 Minimum Parcel Width for Subdivision:

- a) 35.0 metres for *manufactured home park*, subject to Section 8.0; within which:
 - i) a minimum of 12.0 metres shall be provided for each *manufactured home space* abutting an internal road; and
 - ii) a minimum of 6.0 metres shall be provided for each *manufactured home space* abutting a cul-de-sac.

16.2.4 Maximum Number of Dwellings Permitted Per Manufactured Home Space:

- a) one (1) *manufactured home* per *manufactured home space*; and
- b) one (1) *single detached dwelling* permitted per *manufactured home park*.

16.2.5 Minimum Setbacks:

- a) *Buildings and structures*:
 - i) *Front parcel line* 7.5 metres
 - ii) *Rear parcel line* 4.5 metres
 - iii) *Interior side parcel line* 4.5 metres
 - iv) *Exterior side parcel line* 4.5 metres

- b) *Setbacks* within each *manufactured home space* boundary for *buildings* and *structures* (subject to Section 16.8.5(a)):
 - i) Front boundary line 3.0 metres
 - ii) Rear boundary line 1.5 metres
 - iii) Interior boundary line 1.5 metres
 - iv) Exterior boundary line 3.0 metres
- c) *Setbacks* within each *manufactured home space* boundary for an *accessory building* or *structure* (subject to Section 16.8.5(a)):
 - i) Front boundary line 4.5 metres
 - ii) Rear boundary line 1.0 metres
 - iii) Interior boundary line 1.0 metres
 - iv) Exterior boundary line 3.0 metres

16.2.6 Maximum Height:

- a) No *building* or *structure* shall exceed a *height* of 7.0 metres;
- b) No *accessory building* or *structure* shall exceed a *height* of 4.5 metres.

16.2.7 Maximum Manufactured Home Space Coverage:

- a) 45%

16.2.8 Manufactured Home Park Roadway Standards

- a) a second access from a public highway, separated by at least 50.0 metres from the first access shall be provided to each *manufactured home park* use containing greater than fifty (50) *manufactured home spaces*.
- b) a roadway that provides access from a highway to a *manufactured home space* or to a common facility such as a storage area or vehicle parking area in a *manufactured home park* shall be designed, constructed and maintained in accordance with the following standards:
 - i) a maximum grade of 10%;
 - ii) a maximum length of 150 metres when terminating in a cul-de-sac or dead-end;
 - iii) a minimum paved width of 7.0 metres and a minimum cleared width of 15.0 metres; and
 - iv) a minimum vehicle turning radius of 15.0 metres at any cul-de-sac or dead-end.

16.2.9 General Regulations:

- a) a *manufactured home park* use shall be connected to a community sewer system and community water system.
- b) a *retail* use shall not exceed a *gross floor area* of 250.0 m².

16.2.10 Low Density Residential Manufactured Home Park Site Specific (RSM1s) Regulations:

- a) Not applicable.

17.0 COMMERCIAL ZONES

17.1 GENERAL COMMERCIAL (C1) ZONE

17.1.1 Permitted Uses:

Principal Uses:

- a) *alcohol production facility;*
- b) *eating and drinking establishment;*
- c) *indoor recreation;*
- d) *office;*
- e) *outdoor market;*
- f) *personal service establishment;*
- g) *retail;*
- h) *vehicle sales and rental;*

Accessory Uses:

- i) *accessory building or structure, subject to Section 7.1;*
- j) *accessory dwelling, subject to Section 7.2; and*
- k) *car wash.*

17.1.2 Minimum Parcel Size for Subdivision:

- a) 1,000.0 m², subject to Section 8.0.

17.1.3 Minimum Parcel Width for Subdivision:

- a) Not less than 25% of *parcel depth*, subject to Section 8.0.

17.1.4 Maximum Number of Dwellings Permitted Per Parcel:

- a) one (1) *accessory dwelling*.

17.1.5 Minimum Setbacks:

- a) *Buildings and structures:*
 - i) *Front parcel line* 7.5 metres
 - ii) *Rear parcel line* 4.5 metres
 - iii) *Interior side parcel line* 4.5 metres

iv) *Exterior side parcel line*

4.5 metres

17.1.6 Maximum Height:

- a) No *building* or *structure* shall exceed a *height* of 10.0 metres.

17.1.7 Maximum Parcel Coverage:

- a) 50%

17.1.8 General Commercial Site Specific (C1s) Regulations:

- a) Not applicable

17.2 SERVICE COMMERCIAL (CS1) ZONE

17.2.1 Permitted Uses:

Principal Uses:

- a) car wash;
- b) retail;
- c) service industry establishment;
- d) service station;
- e) vehicle sales and rentals;

Accessory Uses:

- f) accessory building or structure, subject to Section 7.1;
- g) accessory dwelling, subject to Section 7.2; and
- h) eating and drinking establishment.

17.2.2 Minimum Parcel Size for Subdivision:

- a) 1,000 m², subject to Section 8.0.

17.2.3 Minimum Parcel Width for Subdivision:

- a) Not less than 25% of *parcel depth*, subject to Section 8.0.

17.2.4 Maximum Number of Dwellings Permitted Per Parcel:

- a) one (1) *accessory dwelling*.

17.2.5 Minimum Setbacks:

- a) *Buildings and structures:*
 - i) *Front parcel line* 7.5 metres
 - ii) *Rear parcel line* 7.5 metres
 - iii) *Interior side parcel line* 3.0 metres
 - iv) *Exterior side parcel line* 4.5 metres
- b) Fuel distribution pumps, storage tanks or devices situated above ground:
 - i) *Front parcel line* 7.5 metres
 - ii) *Rear parcel line* 7.5 metres
 - iii) *Interior side parcel line* 4.5 metres

iv) *Exterior side parcel line*

4.5 metres

17.2.6 Maximum Height:

- a) No *building* or *structure* shall exceed a *height* of 7.5 metres;
- b) No *accessory building* or *structure* shall exceed a *height* of 4.5 metres.

17.2.7 Maximum Parcel Coverage:

- a) 35%

17.2.8 Service Commercial Site Specific (CS1s) Regulations:

- a) Not applicable

18.0 TOURIST COMMERCIAL ZONES

18.1 TOURIST COMMERCIAL (CT1) ZONE

18.1.1 Permitted Uses:

Principal Uses:

- a) *eating and drinking establishment;*
- b) *indoor recreation;*
- c) *outdoor recreation;*
- d) *tourist accommodation;*

Accessory Uses:

- e) *accessory building or structure, subject to Section 7.1;*
- f) *accessory dwelling, subject to Section 7.2;*
- g) *office;*
- h) *personal service establishment, not to exceed 200.0 m² in gross floor area; and*
- i) *retail, not to exceed 250.0 m² in gross floor area.*

18.1.2 Minimum Parcel Size for Subdivision:

- a) 1,000.0 m², subject to Section 8.0.

18.1.3 Minimum Parcel Width for Subdivision:

- a) Not less than 25% of *parcel depth*.

18.1.4 Maximum Number of Dwellings Permitted Per Parcel:

- a) one (1) *accessory dwelling*.

18.1.5 Maximum Floor Area Ratio:

- a) Not applicable

18.1.6 Minimum Setbacks:

- a) *Buildings and structures:*
 - i) *Front parcel line* 7.5 metres
 - ii) *Rear parcel line* 7.5 metres
 - iii) *Interior side parcel line* 4.5 metres

- iv) *Exterior side parcel line* 4.5 metres
- b) *Accessory building or structure:*
 - i) *Front parcel line* 7.5 metres
 - ii) *Rear parcel line* 7.5 metres
 - iii) *Interior side parcel line* 1.5 metres
 - iv) *Exterior side parcel line* 4.5 metres

18.1.7 Maximum Height:

- a) No *building or structure* shall exceed a *height* of 12.0 metres;
- b) No *accessory building or structure* shall exceed a *height* of 4.5 metres.

18.1.8 Maximum Parcel Coverage:

- a) 35%

18.1.9 Tourist Commercial Site Specific (CT1s) Regulations:

- a) in the case of land described as Lot A, Plan KAP28225, District Lots 932, 1525 & 2137, KDYD (375 Rainbow Lake Road), and shown hatched in Figure 18.1.9(a)
 - i) the following principal use shall be permitted on the land in addition to the permitted uses listed in Section 18.1.1:
 - .1 *equestrian centre.*

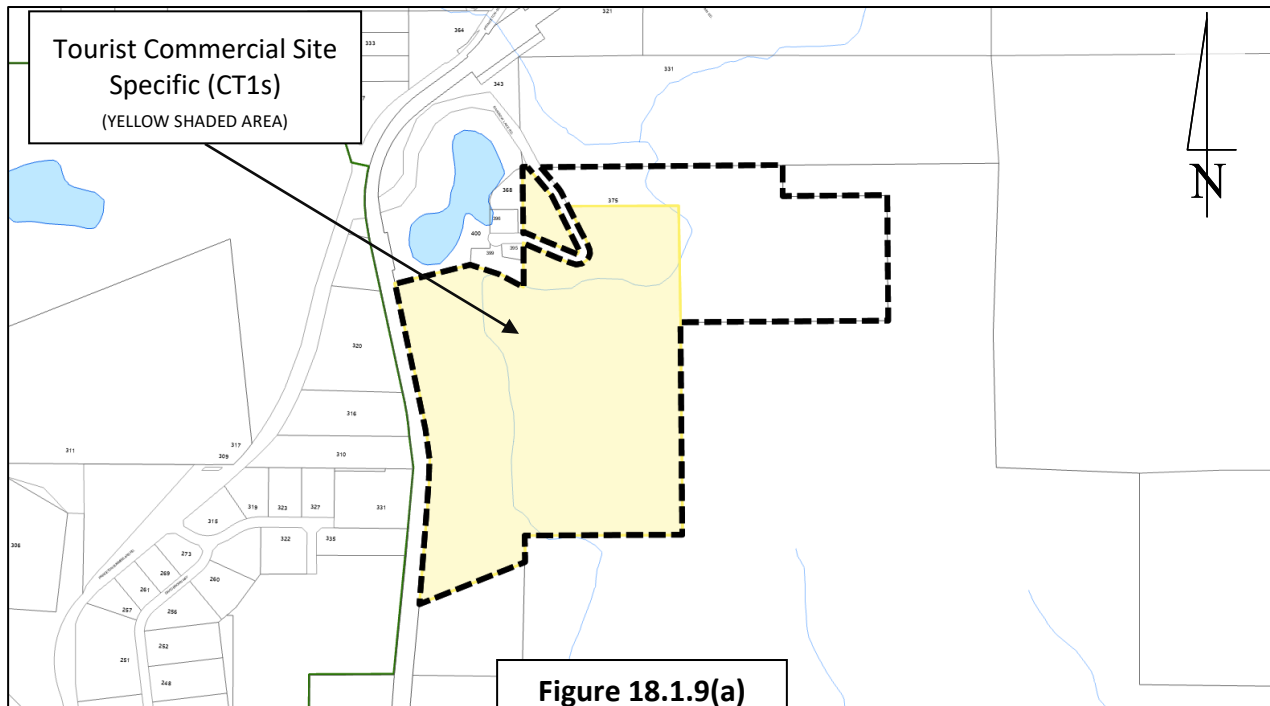

b) in the case of land described as Parcel A, Plan KAP38032, District Lot 104, YDYD, Portion KF41673 (2891 Coalmont Road), and shown hatched in Figure 18.1.9(b):

i) the following uses and no others shall be permitted on the land:

- .1 *tourist accommodation;*
- .2 *single detached dwelling;* and
- .3 *accessory buildings and structures,* subject to Section 7.1.

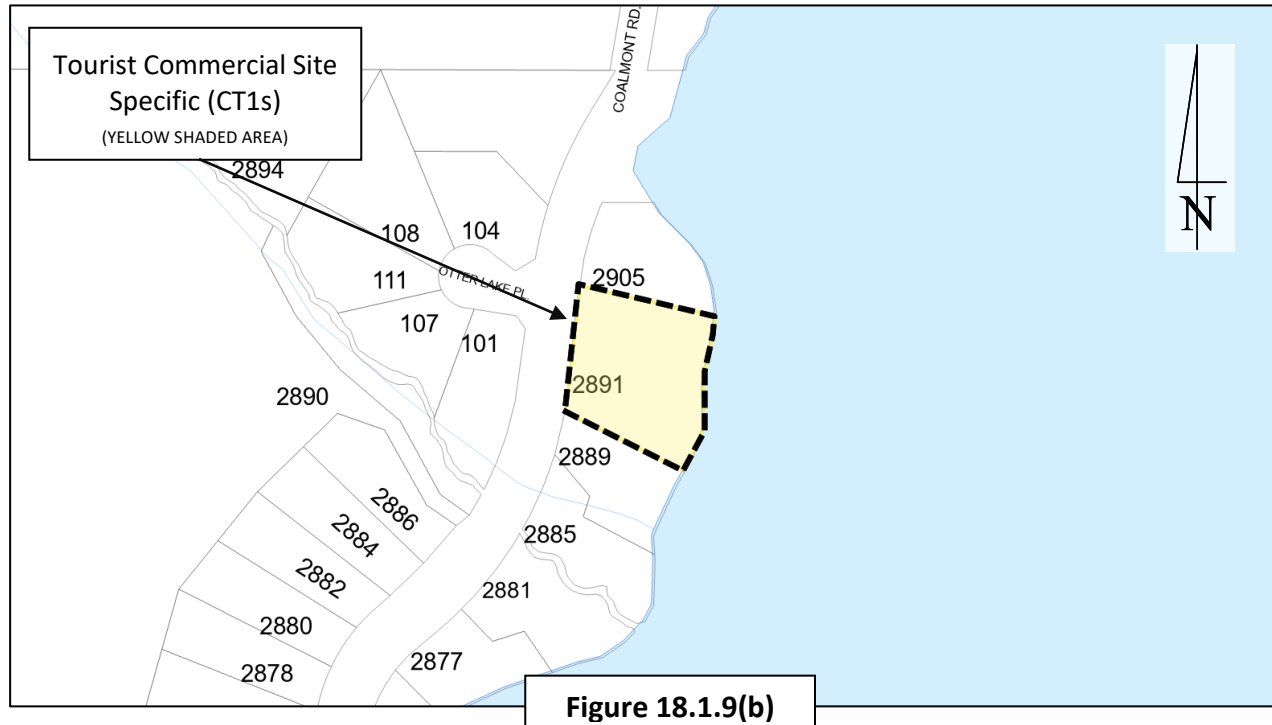

c) in the case of land described as Lot B, Plan KAP77536, District Lot 515, YDYD (104 Snowpatch Road), and shown hatched in Figure 18.1.9(c):

i) the following uses and no others shall be permitted on the land:

- .1 *tourist accommodation;*
- .2 *single detached dwelling;* and
- .3 *accessory buildings and structures,* subject to Section 7.1.

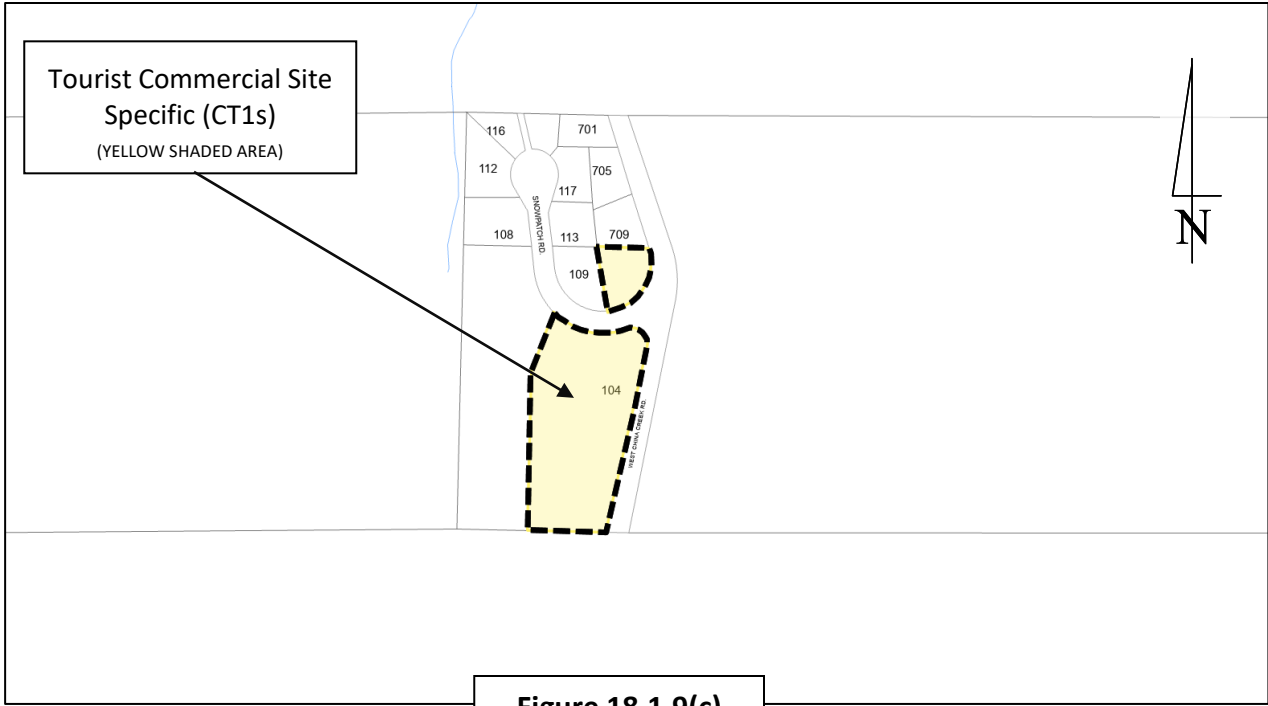

18.2 CAMPGROUND COMMERCIAL (CT2) ZONE

18.2.1 Permitted Uses:

Principal Uses:

- a) *campground*;

Accessory Uses:

- b) *accessory building or structure*, subject to Section 7.1;
- c) *accessory dwelling*, subject to Section 7.2;
- d) *eating and drinking establishment*;
- e) *indoor recreation*; and
- f) *retail*, not to exceed 250.0 m² in *gross floor area*.

18.2.2 Minimum Parcel Size for Subdivision:

- a) 2.0 ha, subject to Section 8.0.

18.2.3 Minimum Parcel Width for Subdivision:

- a) Not less than 25% of the *parcel depth*, subject to Section 8.0.

18.2.4 Maximum Number of Dwellings Permitted Per Parcel:

- a) one (1) *accessory dwelling*.

18.2.5 Minimum Setbacks:

- a) *Buildings and structures*:
 - i) *Front parcel line* 7.5 metres
 - ii) *Rear parcel line* 7.5 metres
 - iii) *Interior side parcel line* 4.5 metres
 - iv) *Exterior side parcel line* 4.5 metres

18.2.6 Maximum Height:

- a) No *building or structure* shall exceed a *height* of 10.0 metres;
- b) despite Section 20.2.6(a), a *tourist cabin* may not exceed a *height* of 5.0 metres.

18.2.7 Maximum Parcel Coverage:

- a) 20%

18.2.8 General Regulations:

- a) the minimum area on which a *campground* use may be undertaken shall be 2.0 ha;
- b) the maximum number of campground units per hectare shall not exceed 75;
- c) not more than 25% of all campground units within a *campground* shall be used for the placement of *tourist cabins*;
- d) a *tourist cabin* may not have a *gross floor area* exceeding 30.0 m² including additions such as covered patios and covered or uncovered decks; and
- e) all provisions in the *Campground Regulations Bylaw No. 2779, 2018*, as amended from time to time that have not been specified in this particular bylaw shall be met.

18.2.9 Campground Commercial Site Specific (CT2s) Regulations:

- a) Not applicable

18.3 GOLF COURSE COMMERCIAL (CT3) ZONE

18.3.1 Permitted Uses:

Principal Uses:

- a) *golf course*;

Accessory Uses:

- b) *accessory building or structure*, subject to Section 7.1;
- c) *accessory dwelling*, subject to Section 7.2.

18.3.2 Minimum Parcel Size for Subdivision:

- a) 20.0 ha, subject to Section 8.0.

18.3.3 Minimum Parcel Width for Subdivision:

- a) Not less than 25% of the *parcel depth*, subject to Section 8.0.

18.3.4 Maximum Number of Dwellings Permitted Per Parcel:

- a) one (1) *accessory dwelling*.

18.3.5 Minimum Setbacks:

- a) *Buildings and structures:*

- i) *Front parcel line* 7.5 metres
- ii) *Rear parcel line* 7.5 metres
- iii) *Interior side parcel line* 4.5 metres
- iv) *Exterior side parcel line* 4.5 metres

18.3.6 Maximum Height:

- a) No *building or structure* shall exceed a *height* of 10.0 metres.

18.3.7 Maximum Parcel Coverage:

- a) 5%

18.3.8 Golf Course Commercial Site Specific (CT3s) Regulations:

- a) Not applicable

19.0 INDUSTRIAL ZONES

19.1 GENERAL INDUSTRIAL (I1) ZONE

19.1.1 Permitted Uses:

Principal Uses:

- a) *agriculture, indoor;*
- b) *construction supply centre;*
- c) *fleet service;*
- d) *manufacturing;*
- e) *outdoor storage;*
- f) *packing, processing and storage of farm products;*
- g) *salvage operation;*
- h) *self-storage;*
- i) *service industry establishment;*
- j) *storage and warehouse;*
- k) *vehicle sales and rentals;*
- l) *veterinary establishment;*
- m) *wholesale business;*

Accessory Uses:

- n) *accessory building or structure, subject to Section 7.1;*
- o) *accessory dwelling, subject to Section 7.2;*
- p) *office; and*
- q) *retail.*

19.1.2 Minimum Parcel Size for Subdivision:

- a) 0.1 ha, subject to Section 8.0.

19.1.3 Minimum Parcel Width for Subdivision:

- a) Not less than 25% of *parcel depth*, subject to Section 8.0.

19.1.4 Maximum Number of Dwellings Permitted Per Parcel:

- a) one (1) *accessory dwelling*.

19.1.5 Minimum Setbacks:

- a) *Buildings and structures:*
 - i) *Front parcel line* 7.5 metres
 - ii) *Rear parcel line* 7.5 metres
 - iii) *Interior side parcel line* 4.5 metres
 - iv) *Exterior side parcel line* 4.5 metres
- b) *Accessory building or structure:*
 - i) *Front parcel line* 7.5 metres
 - ii) *Rear parcel line* 4.5 metres
 - iii) *Interior side parcel line* 4.5 metres
 - iv) *Exterior side parcel line* 4.5 metres

19.1.6 Maximum Building Height:

- a) No *building or structure* shall exceed a *height* of 15.0 metres;
- b) No *accessory building or structure* shall exceed a *height* of 7.0 metres.

19.1.7 Maximum Parcel Coverage:

- a) 60%

19.1.8 General Industrial Site Specific (I1s) Regulations:

- a) Not applicable

19.2 HEAVY INDUSTRIAL (I2) ZONE

19.2.1 Permitted Uses:

Principal Uses:

- a) *agriculture, indoor;*
- b) *commercial card-lock facility;*
- c) *concrete plant;*
- d) *power sub-stations, including generating plants;*
- e) *gravel processing;*
- f) *manufacturing;*
- g) *public maintenance and works yards;*
- h) *salvage operation;*
- i) *sewage treatment plant;*
- j) *stockyard and abattoirs;*

Accessory Uses:

- k) *accessory building or structure, subject to Section 7.1;*
- l) *accessory dwelling, subject to Section 7.2; and*
- m) *office.*

19.2.2 Minimum Parcel Size for Subdivision:

- a) 2,000 m², subject to Section 8.0.

19.2.3 Minimum Parcel Width for Subdivision:

- a) Not less than 25% of *parcel depth*, subject to Section 8.0.

19.2.4 Maximum Number of Dwellings Permitted Per Parcel:

- a) one (1) *accessory dwelling*.

19.2.5 Minimum Setbacks:

- a) *Buildings and structures:*
 - i) *Front parcel line* 7.5 metres
 - ii) *Rear parcel line* 7.5 metres
 - iii) *Interior side parcel line* 4.5 metres
 - iv) *Exterior side parcel line* 4.5 metres

- b) *Accessory building or structure:*
 - i) *Front parcel line* 7.5 metres
 - ii) *Rear parcel line* 4.5 metres
 - iii) *Interior side parcel line* 4.5 metres
 - iv) *Exterior side parcel line* 4.5 metres

19.2.6 Maximum Building Height:

- a) No *building or structure* shall exceed a *height* of 15.0 metres; and
- b) No *accessory building or structure* shall exceed a *height* of 15.0 metres.

19.2.7 Maximum Parcel Coverage:

- a) 60%

19.2.8 Heavy Industrial Site Specific (I2s) Regulations:

- a) In the case of District Lot 983, except Plan H88, YDYD (691 Highway 3), and shown hatched at Figure 19.2.8(a):
 - i) the following uses and no others shall be permitted on the parcel:
 - .1 processing, manufacturing, fabricating, assembling, storing, transporting, distributing and wholesaling of logs and wood products; and
 - .2 retail sales, schools, office buildings and structures accessory to the uses in listed in Section 19.2.8(a)(i).

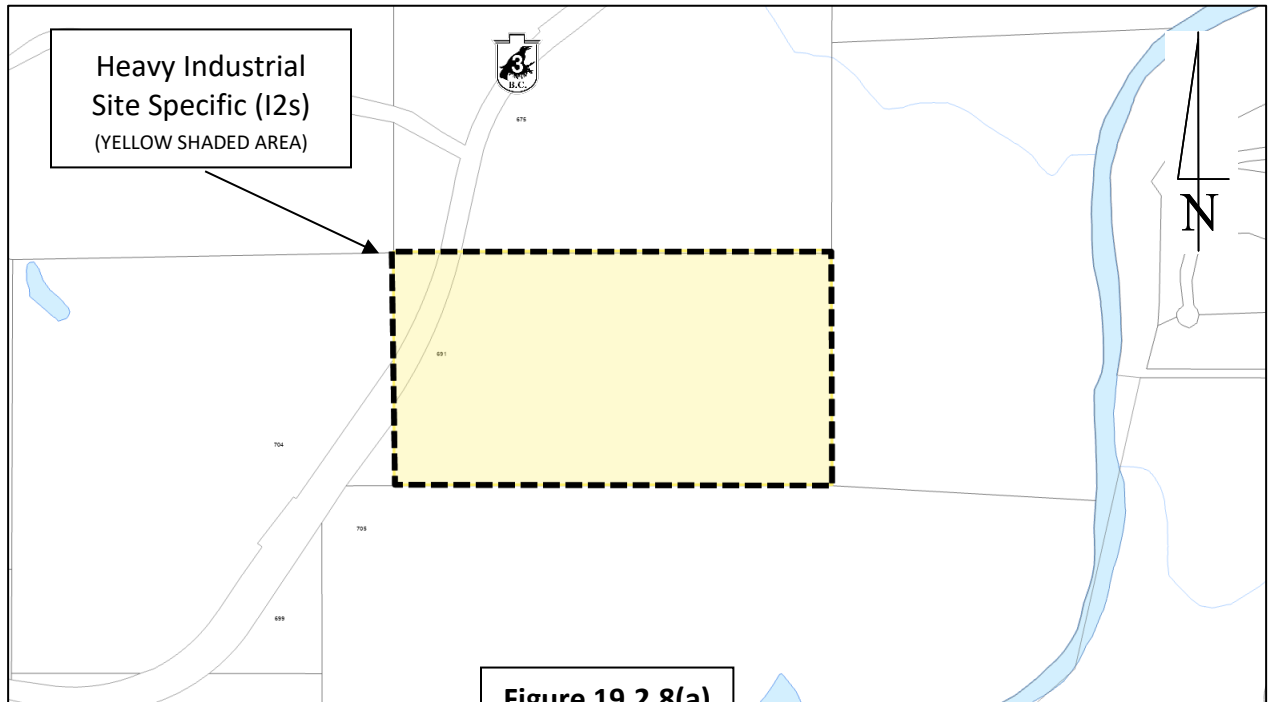

20.0 ADMINISTRATIVE & INSTITUTIONAL ZONES

20.1 ADMINISTRATIVE AND INSTITUTIONAL (AI) ZONE

20.1.1 Permitted Uses:

Principal Uses:

- a) *assembly;*
- b) *cemetery;*
- c) *child care centre;*
- d) *civic facility;*
- e) *community care facility;*
- f) *cultural facility;*
- g) *educational facility;*
- h) *funeral home;*

Accessory Uses:

- i) *accessory building or structure, subject to Section 7.1.*

20.1.2 Minimum Parcel Size for Subdivision:

- a) 500.0 m², subject to Section 8.0.

20.1.3 Minimum Parcel Width for Subdivision:

- a) Not less than 25% of parcel depth

20.1.4 Minimum Setbacks:

a) *Buildings and structures:*

- i) *Front parcel line* 7.5 metres
- ii) *Rear parcel line* 7.5 metres
- iii) *Interior side parcel line* 4.5 metres
- iv) *Exterior side parcel line* 4.5 metres

b) *Accessory building or structure:*

- i) *Front parcel line* 7.5 metres
- ii) *Rear parcel line* 7.5 metres
- iii) *Interior side parcel line* 4.5 metres
- iv) *Exterior side parcel line* 4.5 metres

20.1.5 Maximum Height:

- a) No *building* or *structure* shall exceed a *height* of 15.0 metres

20.1.6 Maximum Parcel Coverage:

- a) 40%

20.1.7 Administrative and Institutional Site Specific (AIs) Regulations:

- a) Not applicable

21.0 PARKS & NATURAL ENVIRONMENT ZONES

21.1 PARKS AND RECREATION (PR) ZONE

21.1.1 Permitted Uses:

Principal Uses:

- a) *park*;
- b) *outdoor recreation*;
- c) *cemetery*;

Accessory Uses:

- d) *accessory building or structure*, subject to Section 7.1;
- e) *accessory dwelling*, subject to Section 7.2;
- f) *carnivals, circuses and fairs*;
- g) *community facilities*;
- h) *interpretation centre*;
- i) *public moorage*; and
- j) *indoor recreation*.

21.1.2 Minimum Parcel Size:

- a) Not applicable

21.1.3 Minimum Parcel Width:

- a) Not applicable

21.1.4 Maximum Number of Dwellings Permitted Per Parcel:

- a) one (1) *accessory dwelling*.

21.1.5 Minimum Setbacks:

a) *Buildings and structures:*

- i) *Front parcel line* 7.5 metres
- ii) *Rear parcel line* 7.5 metres
- iii) *Interior side parcel line* 4.5 metres
- iv) *Exterior side parcel line* 4.5 metres

b) *Accessory building or structure:*

- | | |
|---------------------------------------|------------|
| i) <i>Front parcel line</i> | 7.5 metres |
| ii) <i>Rear parcel line</i> | 7.5 metres |
| iii) <i>Interior side parcel line</i> | 4.5 metres |
| iv) <i>Exterior side parcel line</i> | 4.5 metres |

21.1.6 Maximum Height:

- a) No *building* or *structure* shall exceed a *height* of 15.0 metres.

21.1.7 Maximum Parcel Coverage:

- a) 25%

21.1.8 Parks and Recreation Site Specific (PRs) Regulations:

- a) Not applicable

21.2 CONSERVATION AREA (CA) ZONE

21.2.1 Permitted Uses:

Principal Uses:

- a) *conservation area;*

Accessory Uses:

- b) *accessory building or structure*, subject to Section 7.1;
- c) *accessory dwelling*, subject to Section 7.2; and
- d) interpretation centre.

21.2.2 Minimum Parcel Size for Subdivision:

- a) Not applicable

21.2.3 Minimum Parcel Width for Subdivision:

- a) Not applicable

21.2.4 Maximum Number of Dwellings Permitted Per Parcel:

- a) one (1) *accessory dwelling*.

21.2.5 Minimum Setbacks:

- a) *Buildings and structures:*

- i) *Front parcel line* 7.5 metres
- ii) *Rear parcel line* 7.5 metres
- iii) *Interior side parcel line* 4.5 metres
- iv) *Exterior side parcel line* 4.5 metres

- b) *Accessory building or structure:*

- i) *Front parcel line* 7.5 metres
- ii) *Rear parcel line* 7.5 metres
- iii) *Interior side parcel line* 4.5 metres
- iv) *Exterior side parcel line* 4.5 metres

21.2.6 Maximum Height:

- a) No *building or structure* shall exceed a *height* of 10.0 metres;
- b) No *accessory building or structure* shall exceed a *height* of 4.5 metres.

21.2.7 Maximum Parcel Coverage:

- a) 5%

21.2.8 Conservation Area Site Specific (CAs) Regulations:

- a) Not applicable

22.0 COMPREHENSIVE DEVELOPMENT

22.1 ELKHART LODGE COMPREHENSIVE DEVELOPMENT (CD3) ZONE

22.1.1 Purpose

The purpose of the Elkhart Lodge Comprehensive Development Zone is to create comprehensive, site-specific land use regulations for an approximately 4.0 ha part of the parcel located at 5021 Highway 97C (Coquihalla Connector), which is legally described as Lot 1, Plan KAP68315, District Lot 4531, KDYD (PID: 024-938-041), and hereinafter referred to as the “Elkhart Lodge”, in order to facilitate a highway commercial development catering to the needs of the travelling public.

22.1.2 Location

The property is situated approximately 92 km north of the Town of Princeton and is accessible via Highway 97C (Coquihalla Connector).

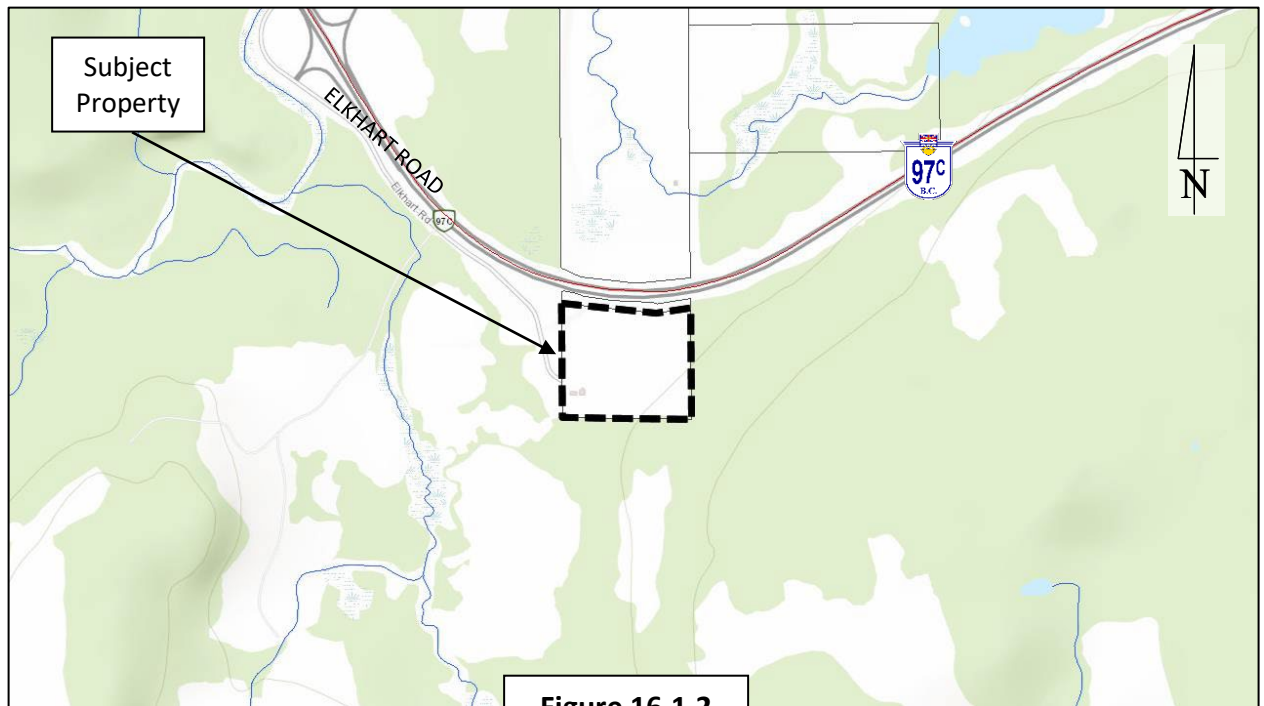

Figure 16.1.2

22.1.3 Background:

The commercial use of the subject property dates to an amendment to the (then) Electoral Area “H” Zoning Bylaw that was adopted by the Regional District Board in 1990. This amendment introduced a “Highway Commercial” Zone on an approximately 1.0 ha part of the property in order to facilitate the development of a service station. This use was subsequently expanded to include tourist accommodation units and accessory restaurant.

22.1.4 Permitted Uses:

Principal Uses:

- a) commercial card-lock facility;
- b) eating and drinking establishment;
- c) hotel;
- d) motel;
- e) outdoor storage;
- f) retail sales, general;
- g) service station;

Accessory Uses:

- h) one (1) accessory dwelling, subject to Section 7.11;
- i) offices;
- j) accessory buildings or structures, subject to Section 7.13.

22.1.5 Minimum Parcel Size for Subdivision:

- a) 4.0 ha

22.1.6 Minimum Parcel Width:

- a) Not less than 25% of parcel depth

22.1.7 Minimum Setbacks:

- a) Buildings and Structures:
 - i) Front share lot line: 7.5 metre
 - ii) Rear share lot line: 7.5 metre
 - iii) Interior side share lot line: 3.0 metre
 - iv) Exterior side share lot line: 4.5 metres

22.1.8 Maximum Height:

- a) No building or structure shall exceed a height of 12.0 metres

22.1.9 Maximum Parcel Coverage:

- a) 35%

22.2 KENNEDY LAKE COMPREHENSIVE DEVELOPMENT ZONE (CD6)

22.2.1 Purpose

The purpose of the Kennedy Lake Comprehensive Development (CD6) Zone is to create comprehensive, site-specific land use regulations for the parcel — hereinafter referred to as “Kennedy Lake” — located at 1916 Kennedy Lake Road (legally described as District Lot 889, Yale Division of Yale District) in order to bring the use of the property into compliance with the Official Community Plan Bylaw and Zoning Bylaw.

22.2.2 Location

The property is situated approximately 20 km south of the Town of Princeton and is situated west of Highway 3, approximately 2,000 metres to the west of the mining operation at Copper Mountain.

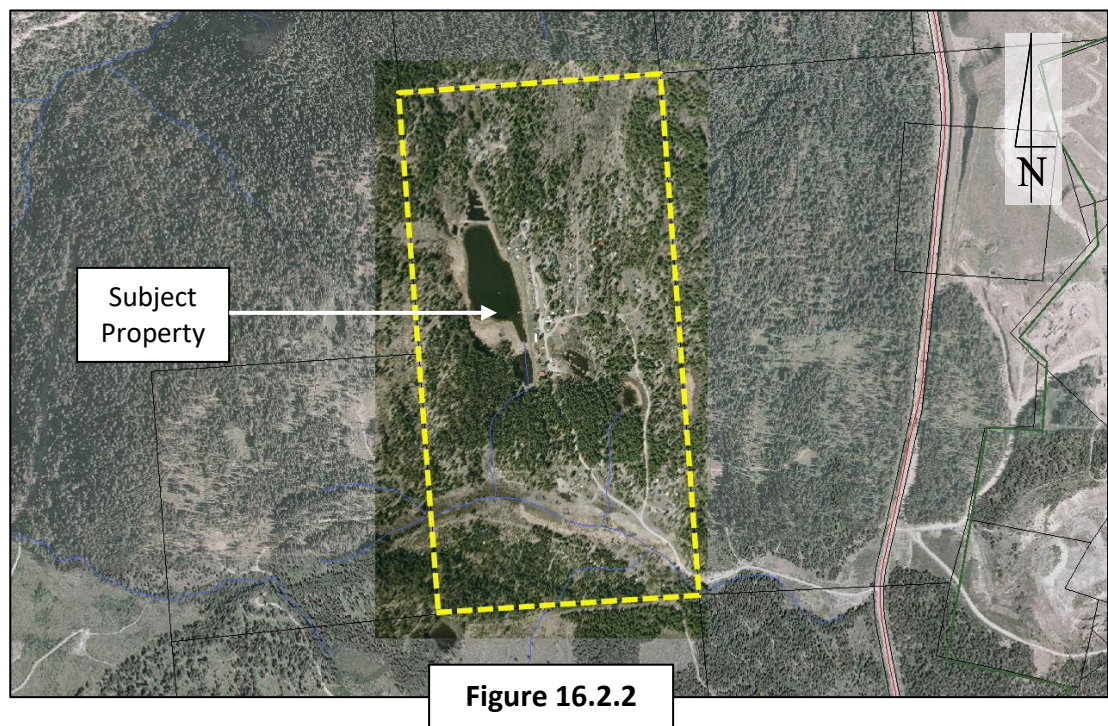

22.2.3 Kennedy Lake Recreational Use Areas

A plan that identifies the Kennedy Lake Recreational Use Areas is included at Schedule ‘4’ to this Bylaw, and forms part of this Bylaw.

22.2.4 Background:

Use of Kennedy Lake for commercial recreation purposes originated in the late 1960’s with the establishment of a campground adjacent to the water body of the same name, which predated the introduction of zoning to Electoral Area “H” in 1974.

With the introduction of zoning, an approximately 16.8 hectare (ha) part of Kennedy Lake encompassing the campground use and accessory dwelling was zoned commercial. This

commercial zoning would be carried forward over a number of land use bylaw reviews undertaken by the Regional District between 1974 and 1997.

In 1982, an application seeking to rezone the whole of the Kennedy Lake property to residential was submitted to the Regional District. This proposal was ultimately abandoned by the property owner, with a similar proposal submitted in 1985 refused by the Regional District Board.

Completion of the Coquihalla Highway in 1986 significantly altered traffic volumes along Highway 3, resulting in reduced commercial traffic to the campground operation. To compensate for this loss of business, the property owner increasingly leased individual parts of the property to interested lessees on an annual basis (under the *Land Title Act*, leases greater than 3 years in length trigger the requirement for subdivision). Consequently, what had been only a few small cabins and permanently parked travel trailers expanded in numbers and extent beyond the 16.8 ha area zoned for commercial uses in 1974, and without due regard for the density regulations contained within the current Zoning Bylaws.

In 2005, the Board approved a rezoning of part of the property to “resort” in order to formalise a mix of recreational vehicles and cabins totaling 132 units. The new zoning contained a provision for an additional 10% expansion (145 units).

By 2013, these numbers had increased to approximately 300 units and the Regional District Board initiated legal action to obtain an injunction ceasing further development of the property. This action was successful and led to the consideration of new zoning to be applied to the property.

22.2.5 Definitions:

In this CD zone:

“non-occupancy use area” means the remainder of the parcel used for recreational purposes that do not require constructed facilities, and as shown on Schedule ‘4’ of this Bylaw;

“parcel” means the land shown outlined in a dashed yellow line on Figure 16.2.2 of this Bylaw;

“recreational use area” means the those portions of the parcel reserved for recreational use purposes, and as shown on Schedule ‘4’ of this Bylaw;

“seasonal cabin” means a building or structure that may contain cooking, eating, washroom, living and sleeping facilities, and is primarily used for occasional or seasonal occupancy. A seasonal cabin includes recreational vehicles with structures affixed or adjacent to said recreational vehicle, and excludes unenclosed roof structures supported by columns and decks not greater than 10.0 m² in area and 0.6 metres in height.

22.2.6 Permitted Uses for Recreational Use Area:

Principal Uses:

- a) seasonal cabins;

- b) recreational vehicles; and

Accessory Uses:

- c) accessory buildings and structures, subject to Section 7.11, including unenclosed roof structures supported by columns and decks not greater than 10.0 m² in area and 0.6 metres in height.

22.2.7 Permitted Uses for Non-Occupancy Use Area:

Principal Uses:

- a) passive recreation.

Accessory Uses:

- b) Not applicable.

22.2.8 Minimum Parcel Size:

- a) 130 hectares

22.2.9 Maximum Density:

- a) In the “Recreational Use Area” shown on Schedule ‘4’ of this Bylaw, the maximum density shall be as follows:
 - i) in the area shown shaded rose quartz and described as “Block A”, the maximum number of:
 - .1 seasonal cabins shall not exceed 22; and
 - .2 recreational vehicles shall not exceed 17.
 - ii) in the area shown shaded creton blue and described as “Block B”, the maximum number of:
 - .1 seasonal cabins shall not exceed 17; and
 - .2 recreational vehicles shall not exceed 8.
 - iii) in the area shown shaded peony pink and described as “Block C”, the maximum number of:
 - .1 seasonal cabins shall not exceed 19; and
 - .2 recreational vehicles shall not exceed 7.
 - iv) in the area shown shaded olivine yellow and described as “Block D”, the maximum number of:
 - .1 seasonal cabins shall not exceed 14; and
 - .2 recreational vehicles shall not exceed 11.
 - v) in the area shown shaded steel blue and described as “Block E”, the maximum number of:
 - .1 seasonal cabins shall not exceed 13; and

- .2 recreational vehicles shall not exceed 5.
- vi) in the area shown shaded indicolite green and described as “Block F”, the maximum number of:
 - .1 seasonal cabins shall not exceed 10; and
 - .2 recreational vehicles shall not exceed 11.
- vii) in the area shown shaded sugilite sky and described as “Block G”, the maximum number of:
 - .1 seasonal cabins shall not exceed 10; and
 - .2 recreational vehicles shall not exceed 3.
- viii) in the area shown shaded lepidolite lilac and described as “Block H”, the maximum number of:
 - .1 seasonal cabins shall not exceed 16; and
 - .2 recreational vehicles shall not exceed 9.
- ix) in the area shown shaded dark gray and described as “Block I”, the maximum number of:
 - .1 seasonal cabins shall not exceed 14; and
 - .2 recreational vehicles shall not exceed 4.
- x) in the area shown shaded light gray and described as “Block J”, the maximum number of:
 - .1 seasonal cabins shall not exceed 14; and
 - .2 recreational vehicles shall not exceed 24.
- xi) in the area shown shaded orange and described as “Block K”, the maximum number of:
 - .1 seasonal cabins shall not exceed 8; and
 - .2 recreational vehicles shall not exceed 9.
- xii) in the area shown shaded coral and described as “Block L”, the maximum number of:
 - .1 seasonal cabins shall not exceed 14; and
 - .2 recreational vehicles shall not exceed 12.
- xiii) in the area shown shaded tan and described as “Block M”, the maximum number of:
 - .1 seasonal cabins shall not exceed 7; and
 - .2 recreational vehicles shall not exceed 8.
- xiv) in the area shown shaded spruce green and described as “Block N”, the maximum number of:

- .1 seasonal cabins shall not exceed 9; and
- .2 recreational vehicles shall not exceed 12.
- xv) in the area shown shaded electron gold and described as “Block O”, the maximum number of:
 - .1 seasonal cabins shall not exceed 6; and
 - .2 recreational vehicles shall not exceed 8.
- xvi) in the area shown shaded solar yellow and described as “Block P”, the maximum number of:
 - .1 seasonal cabins shall not exceed 8; and
 - .2 recreational vehicles shall not exceed 6.
- b) In the “Non-Occupancy Use Area” shown on Schedule ‘4’ of this Bylaw, no seasonal cabins or recreational vehicles shall be permitted.

22.2.10 Maximum Parcel Coverage:

- a) 10%

22.2.11 Minimum Setbacks:

- a) Buildings and structures:
 - i) Front parcel line 7.5 metres
 - ii) Rear parcel line 7.5 metres
 - iii) Interior side parcel line 7.5 metres
 - iv) Exterior side parcel line 7.5 metres
- b) Accessory buildings and structures:
 - i) Front parcel line 7.5 metres
 - ii) Rear parcel line 7.5 metres
 - iii) Interior side parcel line 7.5 metres
 - iv) Exterior side parcel line 7.5 metres
- c) despite Section 16.2.11(a)(iii), the minimum interiors side parcel line setback for those buildings labeled 8-10 on Schedule ‘4’ shall be as follows:
 - i) Interior side parcel line 0.0 metres

22.2.12 Maximum Height:

- a) No building or structure shall exceed a height of 7.5 metres, with the exception of those buildings labeled 1-7 on Schedule ‘4’, which shall not exceed a height of 10.0 metres;
- b) No accessory building or structure shall exceed a height of 5.0 metres.

22.2.13 Maximum Floor Area:

- a) The maximum floor area of a “seasonal cabin” shall not exceed 90 m², with the exception of those buildings labeled 1-7 on Schedule ‘4’, which shall not exceed a maximum floor area of 150.0 m².

~ end of Schedule ‘1’ ~